

# Runoff Reduction Field Monitoring in Cherry Creek Basin



Prepared for:  
Mile High Flood District  
Southeast Metro Stormwater Authority  
Cherry Creek Basin Water Quality Authority

Prepared By:  
Chris Olson, PhD, PE  
Stacy Wilson  
2490 West 26<sup>th</sup> Avenue, Suite 100A  
Denver, CO 80211  
(303) 480-1700



---

Wright Water Engineers, Inc.

June 2024

221-065.000

**TABLE OF CONTENTS**

|  | <u>Page</u> |
|--|-------------|
| <b>LIST OF ACRONYMS .....</b>  | <b>vi</b>   |
| <b>EXECUTIVE SUMMARY .....</b>   | <b>ES-1</b> |
| <b>1.0 INTRODUCTION .....</b>  | <b>1</b>    |
| <b>2.0 BACKGROUND .....</b>  | <b>1</b>    |
| 2.1 Applicable State Regulations Related to Runoff Reduction .....                   | 1           |
| 2.2 Criteria and Methods for Designing and Evaluating Receiving Pervious Areas ..... | 4           |
| 2.2.1 MHFD .....   | 4           |
| 2.2.2 SEMSWA .....   | 5           |
| <b>3.0 PROJECT OBJECTIVES .....</b>  | <b>6</b>    |
| <b>4.0 METHODS AND MONITORING SITES .....</b>  | <b>6</b>    |
| <b>5.0 GRASS SWALES (UNDERDRAINED) .....</b>   | <b>9</b>    |
| 5.1 Methods .....  | 9           |
| 5.1.1 Simulated Runoff Tests (SRTs) .....  | 9           |
| 5.1.1.1 Inflow Rate and Volume .....   | 9           |
| 5.1.1.2 Surface Flow (“Wetted Length”) Measurements .....                            | 9           |
| 5.1.1.3 Underdrain Outflow Rate and Volume .....                                     | 9           |
| 5.1.1.4 Runoff Reduction Calculations .....  | 10          |
| 5.1.2 Ambient Monitoring .....   | 10          |
| 5.2 SEMSWA .....   | 11          |
| 5.2.1 Introduction .....   | 11          |
| 5.2.2 Summary of SRTs .....  | 12          |
| 5.2.3 SRTs – Results and Discussion .....  | 15          |
| 5.2.4 Ambient Monitoring – Results and Discussion .....                              | 19          |
| 5.2.5 Soil Analysis .....  | 21          |
| 5.3 RoadSafe .....   | 21          |
| 5.3.1 Introduction .....   | 21          |
| 5.3.2 SRT Summary .....  | 23          |
| 5.3.2.1 SRT 1 – September 6, 2023 .....  | 23          |
| 5.3.2.2 SRT 2 – September 18, 2023 .....   | 23          |
| 5.3.2.3 SRT 3 – September 26, 2023 .....   | 24          |
| 5.3.2.4 SRT 4 – October 5, 2023 .....  | 25          |
| 5.3.2.5 SRT - Results and Discussion .....   | 26          |
| 5.3.3 Ambient Monitoring – Results and Discussion .....                              | 27          |

# Runoff Reduction Field Monitoring in Cherry Creek Basin

---

|            |   |           |
|------------|---|-----------|
| 5.3.4      | Soil Analysis.....                                | 28        |
| 5.4        | Central Centennial .....                          | 29        |
| 5.4.1      | Introduction .....                                | 29        |
| 5.4.2      | Summary of SRTs .....                             | 30        |
| 5.4.3      | SRTs – Results and Discussion .....               | 31        |
| 5.4.4      | Ambient Monitoring – Results and Discussion ..... | 36        |
| 5.4.5      | Soil Analysis – Results and Discussion.....       | 37        |
| 5.5        | Smith & Smith .....                               | 38        |
| 5.5.1      | Introduction .....                                | 38        |
| 5.5.2      | SRTs .....  | 39        |
| 5.5.2.1    | SRT 1 – September 6, 2023 .....                   | 40        |
| 5.5.2.2    | SRT 2 – September 18, 2023 .....                  | 41        |
| 5.5.2.3    | SRT 3 – September 26, 2023 .....                  | 42        |
| 5.5.2.4    | SRT 4 – October 5, 2023 .....                     | 42        |
| 5.5.2.5    | SRT - Summary Results and Discussion.....         | 43        |
| 5.5.3      | Ambient Monitoring – Results and Discussion ..... | 43        |
| 5.5.4      | Soil Analysis – Results and Discussion.....       | 44        |
| <b>6.0</b> | <b>INFILTRATION BASINS .....</b>                  | <b>46</b> |
| 6.1        | Introduction .....                                | 46        |
| 6.2        | CCSP Lake Loop Infiltration Basin.....            | 47        |
| 6.2.1      | Introduction .....                                | 47        |
| 6.2.2      | Ambient Monitoring – Methods.....                 | 48        |
| 6.2.3      | Ambient Monitoring – Results and Discussion ..... | 48        |
| 6.2.4      | Soil Sampling .....                               | 50        |
| 6.3        | CCSP Mountain Loop Infiltration Basin/Swale.....  | 51        |
| 6.3.1      | Introduction .....                                | 51        |
| 6.3.2      | Ambient Monitoring Methods .....                  | 52        |
| 6.3.3      | Ambient Monitoring – Results and Discussion ..... | 54        |
| 6.3.4      | Soil Sampling .....                               | 57        |
| 6.4        | 17 Mile House Farm Park .....                     | 58        |
| 6.4.1      | Introduction .....                                | 58        |
| 6.4.2      | Summary of SRTs .....                             | 59        |
| 6.4.3      | SRTs – Results and Discussion .....               | 60        |
| 6.4.4      | Soil Analysis.....                                | 61        |
| <b>7.0</b> | <b>GRASS/VEGETATED BUFFERS .....</b>              | <b>63</b> |
| 7.1        | Introduction .....                                | 63        |
| 7.2        | Summary of SRTs.....                              | 66        |

# Runoff Reduction Field Monitoring in Cherry Creek Basin

---

|             |  |           |
|-------------|--|-----------|
| 7.3         | SRT – Results and Discussion .....                               | 66        |
| 7.4         | Soil Analysis.....   | 69        |
| <b>8.0</b>  | <b>SUMMARY AND CONCLUSIONS .....</b>                             | <b>71</b> |
| 8.1         | Engineered Grass Swales with Underdrains .....                   | 71        |
| 8.2         | Minimally Engineered and Non-Engineered Infiltration Basins..... | 72        |
| 8.3         | Non-Engineered Grass/Vegetated Buffers .....                     | 73        |
| <b>9.0</b>  | <b>RECOMMENDATIONS .....</b>                                     | <b>74</b> |
| 9.1         | Engineered Grass Swales with Underdrains .....                   | 74        |
| 9.1.1       | Runoff Reduction “Credits” .....                                 | 74        |
| 9.1.2       | Swale Check Dams .....   | 74        |
| 9.1.3       | Modified Swale Underdrain Designs .....                          | 74        |
| 9.1.4       | Construction and Maintenance .....                               | 75        |
| 9.2         | Minimally-engineered and Non-Engineered Infiltration Basins..... | 75        |
| 9.3         | Non-engineered Grass/Vegetated Buffers.....                      | 76        |
| <b>10.0</b> | <b>REFERENCES.....</b>   | <b>78</b> |

## Tables

|           |  |    |
|-----------|--|----|
| Table 1.  | Quick reference sizing for RPAs, including grass buffers.....                                      | 5  |
| Table 2.  | Summary of monitoring sites and methods used at each site .....                                    | 8  |
| Table 3.  | Characteristics of SEMSWA southeast bioswale .....   | 12 |
| Table 4.  | Summary of SRTs performed at the SEMSWA bioswale.....  | 13 |
| Table 5.  | Runoff volume and peak flow reduction measured during SRTs at the SEMSWA site.                     | 19 |
| Table 6.  | Underdrain discharge presence/absence in response to precipitation events at the SEMSWA site ..... | 20 |
| Table 7.  | Design characteristics of RoadSafe grass swale .....   | 22 |
| Table 8.  | Summary of SRTs performed at RoadSafe grass swale.....   | 23 |
| Table 9.  | Runoff from underdrain in response to precipitation events at the RoadSafe site .....              | 27 |
| Table 10. | Design characteristics of Central Centennial grass swales.....                                     | 30 |
| Table 11. | Summary of SRTs performed at Central Centennial southeast grass swale .....                        | 31 |
| Table 12. | Runoff volume and peak flow reduction measured during SRTs at Central Centennial .....             | 36 |
| Table 13. | Runoff from underdrain in response to precipitation events at Central Centennial site .....        | 37 |
| Table 14. | Characteristics of Smith & Smith grass/rock swale .....  | 39 |
| Table 15. | Summary of SRTs performed at Smith & Smith grass/rock swale .....                                  | 40 |
| Table 16. | Runoff from underdrain in response to precipitation events at Smith & Smith site .....             | 44 |
| Table 17. | Ponding in Lake Loop infiltration basin in response to precipitation events.....                   | 49 |
| Table 18. | Precipitation metrics and ponding absence/presence at the Mountain Loop infiltration basin .....   | 55 |



# Runoff Reduction Field Monitoring in Cherry Creek Basin

---

|  |    |
|--|----|
| Table 19. Precipitation, ponding, and infiltration rates measured at the Mountain Loop infiltration basin..... | 56 |
| Table 20. Summary of SRTs completed at 17 Mile House infiltration basin.....                                   | 60 |
| Table 21. Infiltration rates calculated from the SRTs.....   | 61 |
| Table 22. Summary of SRTs at 17 Mile House and Parker Town Hall grass buffers.....                             | 66 |
| Table 23. Results of SRTs performed at 17 Mile House grass buffer.....   | 67 |
| Table 24. Results of SRTs performed at the Parker Town Hall buffer.....  | 68 |
| Table 25. UIA:RPA ratios that would provide 100% runoff reduction based on SRT results.....                    | 69 |
| Table 26. Infiltration basin characteristics relevant to potential design criteria.....                        | 76 |
| Table 27. Grass/Vegetated Buffer characteristics relevant to potential design criteria.....                    | 77 |

## Figures

|  |    |
|--|----|
| Figure 1. SEMSWA office with southeast swale and contributing area.....  | 12 |
| Figure 2. Leaking from the bottom of the underdrain during SRT.....  | 13 |
| Figure 3. Leaking from irrigation system.....  | 14 |
| Figure 4. Fourth cleanout discovered during September 6, 2023 SRT.....   | 14 |
| Figure 5. Cumulative inflow and outflow volumes for SRTs at the SEMSWA site.....   | 15 |
| Figure 6. Volume reduction observed for SRTs at the SEMSWA site.....   | 16 |
| Figure 7. Instantaneous weir outflow during SRTs at the SEMSWA site.....   | 16 |
| Figure 8. Peak flow reduction observed at SEMSWA SRTs.....   | 17 |
| Figure 9. Wetted length and total inflow volume during SRTs at the SEMSWA site.....  | 18 |
| Figure 10. Wetted length and inflow rate during SRTs at SEMSWA site.....   | 18 |
| Figure 11. Soil texture analysis of SEMSWA site.....   | 21 |
| Figure 12. RoadSafe site with combination grass buffer and grass swale with red flow direction arrow.....  | 22 |
| Figure 13. Two sandbags placed end to end functioned as check dams during the third and fourth SRTs at RoadSafe.....                               | 24 |
| Figure 14. Three sandbag check dams placed at 25, 50, and 75 feet down the length of the grass swale during the third SRT at RoadSafe.....         | 25 |
| Figure 15. Four sandbag check dams installed at 25, 50, 75, and 100 feet down the length of the grass swale during the fourth SRT at RoadSafe..... | 26 |
| Figure 16. Screenshot from RoadSafe construction drawings showing inlet pipe, riprap and underdrain locations (circled in red).....                | 28 |
| Figure 17. Soil texture analysis of RoadSafe site.....   | 29 |
| Figure 18. Central Centennial industrial building with two swales draining to single outlet structure (Google Earth image).....                    | 30 |
| Figure 19. Cumulative inflow and outflow during SRTs at Central Centennial site.....   | 32 |
| Figure 20. Volume reduction observed at Central Centennial SRTs.....   | 32 |
| Figure 21. Instantaneous weir flow during SRTs at Central Centennial Site.....   | 33 |
| Figure 22. Peak flow reduction observed at Central Centennial SRTs.....  | 34 |
| Figure 23. Wetted length and inflow volume during SRTs at Central Centennial site.....   | 35 |
| Figure 24. Wetted length and inflow rate during SRTs at Central Centennial site.....   | 35 |
| Figure 25. Soil texture analysis of Central Centennial site.....   | 38 |

# Runoff Reduction Field Monitoring in Cherry Creek Basin

---

|  |    |
|--|----|
| Figure 26. Smith & Smith industrial building with grass/rock swale.....  | 39 |
| Figure 27. Upstream flow (to the left of the fire hose in the photo) observed during the first SRT at Smith & Smith site.....    | 40 |
| Figure 28. Flow overtopping the outlet box and outflows from the underdrain observed during the first SRT at Smith & Smith ..... | 41 |
| Figure 29. Flow observed in rocks during SRTs at Smith & Smith site .....  | 42 |
| Figure 30. Soil texture analysis of Smith & Smith site.....  | 45 |
| Figure 31. Study infiltration basins .....   | 46 |
| Figure 32. Approximate Lake Loop parking and grassy area draining to infiltration basin.....                                     | 47 |
| Figure 33. Installation of camera and staff gauge in Lake Loop basin .....   | 48 |
| Figure 34. Ponding observed at Lake Loop basin during the July 4 – 5, 2023, precipitation event .....                            | 49 |
| Figure 35. Ponding event observed at Lake Loop basin on July 4, 2023.....  | 50 |
| Figure 36. Soil particle size distribution at Lake Loop basin .....  | 51 |
| Figure 37. Approximate Mountain Loop parking area draining to infiltration basin .....   | 52 |
| Figure 38. Camera installed adjacent to Mountain Loop swale with staff gauge .....   | 53 |
| Figure 39. Installation of camera and staff gauge in Mountain Loop basin with ponded water visible .....                         | 53 |
| Figure 40. Observable runoff at the Mountain Loop swale .....  | 54 |
| Figure 41. Ponding observed in the Mountain Loop infiltration basin on July 5, 2023.....   | 55 |
| Figure 42. Ponding in Mountain Loop infiltration basin in response to precipitation events.....                                  | 56 |
| Figure 43. Soil particle size distribution at Mountain Loop infiltration basin .....   | 57 |
| Figure 44. Soil particle size distribution at Mountain Loop swale.....   | 58 |
| Figure 45. 17 Mile House infiltration basin.....   | 59 |
| Figure 46. SRT at 17 Mile House infiltration basin.....  | 60 |
| Figure 47. Wetted perimeter following four SRTs at 17 Mile House infiltration basin .....  | 61 |
| Figure 48. Depth measured at the staff gauge throughout SRTs at 17 Mile House infiltration basin .....                           | 62 |
| Figure 49. Soil texture analysis of 17 Mile House infiltration basin .....   | 62 |
| Figure 50. 17 Mile House grass buffer site .....   | 64 |
| Figure 51. 17 Mile House grass buffer .....  | 64 |
| Figure 52. Parker Town Hall grass buffer site .....  | 65 |
| Figure 53. Parker Town Hall grass buffer .....   | 65 |
| Figure 54. WWE staff collecting GPS data around the wetted perimeter following SRT .....   | 66 |
| Figure 55. Wetted perimeter following SRTs at 17 Mile House grass buffer .....   | 67 |
| Figure 56. Wetted perimeter following SRTs at Parker Town Hall buffer .....  | 68 |
| Figure 57. Soil texture analysis of 17 Mile House buffer.....  | 70 |
| Figure 58. Soil texture analysis of Parker Town Hall buffer .....  | 70 |

## Appendices

### APPENDIX 1: WEIR BOX DESIGN AND RATING CURVES

### APPENDIX 2: SOIL SAMPLING RESULTS

# Runoff Reduction Field Monitoring in Cherry Creek Basin

---

## LIST OF ACRONYMS

|        |   |
|--------|---|
| CCBWQA | Cherry Creek Basin Water Quality Authority    |
| CCSP   | Cherry Creek State Park                       |
| CDPHE  | Colorado Department of Health and Environment |
| cm     | centimeter                                    |
| ft     | feet  |
| GARR   | Gage-Adjusted Radar Rainfall                  |
| gal    | gallons                                       |
| gpm    | gallons per minute                            |
| hr     | hour  |
| HSG    | Hydrologic Soil Group                         |
| in/hr  | inches per hour                               |
| MDCIA  | Minimized Directly Connected Impervious Area  |
| MHFD   | Mile High Flood District                      |
| min    | minute  |
| MS4    | Municipal Separate Storm Sewer System         |
| NRCS   | Natural Resources Conservation Service        |
| RPA    | Receiving Pervious Area                       |
| SCM    | Stormwater Control Measure                    |
| SEMSWA | Southeast Metro Stormwater Authority          |
| sf     | square feet                                   |
| SRT    | Simulated Runoff Test                         |
| SWMM   | EPA Stormwater Management Model               |
| UIA    | Unconnected Impervious Area                   |
| USDCM  | Urban Storm Drainage Criteria Manual          |
| WQCV   | Water Quality Capture Volume                  |
| WSS    | Web Soil Survey                               |
| WWE    | Wright Water Engineers, Inc.                  |

### EXECUTIVE SUMMARY

During 2022-2023, Mile High Flood District (MHFD), Southeast Metro Stormwater Authority (SEMSWA), and Cherry Creek Basin Water Quality Authority (CCBWQA) jointly funded the “Runoff Reduction Field Monitoring in Cherry Creek Basin” project to collect field data and evaluate the runoff reduction effectiveness of “receiving pervious areas” (RPA). RPAs such as grass swales, buffers and infiltration basins are designed to capture and infiltrate runoff generated from unconnected impervious areas. Various municipal separate storm sewer system (MS4) permits applicable within the Cherry Creek Basin and the Cherry Creek Reservoir Control Regulation 72 allow runoff reduction (via infiltration, evaporation and/or evapotranspiration) from new development and redevelopment projects as a stormwater control measure (SCM). Design criteria for RPAs, particularly grass swales and buffers, have been developed by MHFD and SEMSWA. MHFD has also developed computational methods for estimating runoff reduction from RPAs. However, there has been very little monitoring of RPAs to measure their actual runoff reduction performance in the field. Experience has demonstrated that field monitoring results provide valuable information to inform design criteria and performance expectations. The project involved field monitoring of nine different RPAs using simulated runoff tests, time-lapse photography, and precipitation data analysis. Key conclusions and recommendations are summarized below.

Engineered grass swales with underdrains provide highly variable runoff reduction, with at least some of the variation likely explained by design and construction issues. One swale demonstrated runoff volume reduction exceeding 50%; however, other swales showed considerably less reduction. Underdrain discharge was observed for most precipitation events exceeding 0.1 inches. Construction and/or maintenance issues were identified as contributing to the poor performance of two of the swales. Recommendations for including relatively small check dams in swales and modifying underdrain designs could improve runoff reduction considerably.

The two minimally-engineered and one non-engineered infiltration basins monitored for this project performed extremely well, providing 100% runoff volume reduction for precipitation events (both actual and simulated) representative of the water quality event (0.6 inches). Measured infiltration rates were high enough to completely infiltrate all captured runoff within 24 hours and often much less time. The non-engineered infiltration basin in the study was in Hydrologic Soil Group B soils in a relatively undisturbed condition. Infiltration basins can be designed and constructed with less infrastructure (e.g., inflow/outflow structures) and smaller footprints compared to other RPAs and should strongly be considered as an acceptable RPA within Cherry Creek Basin. These may be particularly well suited to Regulation 72 Tier 2 development sites.

The non-engineered grass/vegetated buffers monitored for this project were not specifically designed and constructed as buffers but were considered representative of potential buffers that could be included as SCMs. Measured infiltration rates were relatively high (5 – 6 in/hr at one site and 15–32 in/hr at another) with vegetation density being the primary factor differentiating the two sites. The results suggest that properly sized buffers with adequate soil properties for infiltrating

## **Runoff Reduction Field Monitoring in Cherry Creek Basin**

---

runoff may provide 100% runoff reduction for precipitation events equivalent to the water quality event using smaller footprints than current design criteria suggest<sup>1</sup>.

---

<sup>1</sup> The Runoff Reduction computational method assumes uniform distribution for the entire buffer area based on infiltration parameters using regional Horton's infiltration parameters.



## 1.0 INTRODUCTION

This report documents the work performed by Wright Water Engineers, Inc. (WWE) for the “Runoff Reduction Field Monitoring in Cherry Creek Basin” project (Project). Mile High Flood District (MHFD), Southeast Metro Stormwater Authority (SEMSWA), and Cherry Creek Basin Water Quality Authority (CCBWQA) jointly funded the project to collect field data and evaluate the runoff reduction effectiveness of “receiving pervious areas” (RPA). All three project sponsors have vested interests in better understanding how well RPAs provide runoff reduction based on actual field monitoring. MHFD has developed design criteria for RPAs and methods for evaluating the effectiveness of RPAs. Many local governments and organizations (including SEMSWA) adopt these criteria into their local stormwater criteria and standards. SEMSWA and CCBWQA provide additional guidance and criteria for stormwater management to address requirements specific to the Cherry Creek Reservoir drainage basin under Regulation 72.

## 2.0 BACKGROUND

Urban development (or redevelopment) generally increases the amount of impervious surface, which increases the volume and rate of runoff generated during precipitation events. Reducing the volume of additional runoff discharged from a site is a pillar of urban stormwater management. In fact, it is the first step in MHFD’s Four-Step Process to minimize adverse impacts of urbanization, which has been adopted by many stormwater management entities in Colorado.

Runoff reduction can be achieved by providing opportunities for runoff to infiltrate into underlying soils. Stormwater control measures (SCMs) such as grass buffers, grass swales, and infiltration basins can provide such opportunities when implemented on a site. Following the Four Component Land Use Model<sup>2</sup>, grass buffers and grass swales are classified as RPAs and the impervious areas that drain to RPAs are classified as “unconnected impervious areas” (UIA).

### 2.1 Applicable State Regulations Related to Runoff Reduction

Cherry Creek Reservoir Control Regulation #72 (5 CCR 1002-72) establishes nutrient controls required for the Cherry Creek Reservoir Basin. The regulation, as updated in 2022, allows runoff reduction as an option for meeting SCM requirements. The level of runoff reduction required varies depending on the size of the development and location relative to stream preservation areas, as defined in Regulation 72. Three tiers of development and redevelopment are addressed in the regulation.

For “Tier 3”<sup>3</sup> development and redevelopment projects exceeding one or more acres of land disturbance, the performance-based design standards in the applicable Colorado Department of

---

<sup>2</sup> See MHFD Urban Storm Drainage Criteria Manual, Volume 3.

<sup>3</sup> CR 72 defines “Tier 3 development and redevelopment” as land disturbance of one acre or more or land disturbance that is part of a larger common plan of development or sale that disturbs one acre or more. Tier 3 projects are subject to MS4 permit requirements.

## Runoff Reduction Field Monitoring in Cherry Creek Basin

---

Public Health and Environment (CDPHE) Municipal Separate Storm Sewer System (MS4) permit requirements apply. Depending on the project location, the MS4 Permit for the City of Aurora (COS000003), Colorado Department of Transportation (COS000005), the Non-standard General Permit (COR070000), or the Cherry Creek Reservoir Basin General Permit (COR080000) apply. For simplicity, the language related to runoff reduction from the most recently updated Non-standard MS4 Permit (COR070000) is provided for context:

***Runoff Reduction Standard:*** *The control measure(s) is designed to infiltrate into the ground where site geology permits, evaporate, or evapotranspire a quantity of water equal to 60% of what the calculated WQCV would be if all impervious area for the applicable development site discharged without infiltration. This base design standard can be met through practices such as green infrastructure. “Infiltrate” is the act of stormwater runoff infiltrating into the ground without release to the MS4. An underdrain can be used for runoff in excess of the 60% standard, provided that the 60% of the calculated WQCV has infiltrated. A separation distance of 2 feet is required between the bottom of the infiltration control measure and the elevation of the top of bedrock or the expected seasonally high ground water table, including alluvial groundwater, unless a site specific design has determined that a reduced depth would allow for necessary infiltration rates, structure stability associated with expanding bedrock, and prevent contamination of groundwater associated with pollutants present at the site.*

Alternatively, for sites that discharge to regional water quality capture volume (WQCV) facilities, runoff reduction is required in accordance with the “20/10 Rule” stated as follows in COR070000:

***Applicable Development Site Draining to a Regional WQCV Facility:*** *[...] Before discharging to a water of the state, at least 20% of the impervious area of the applicable development site must drain through a receiving pervious area control measure comprising a footprint of at least 10% of the impervious area draining to it. The control measure must be designed in accordance with a design manual identified by the permittee. In addition, the stream channel between the discharge point of the applicable development site and the regional WQCV facility must be stabilized.*

For sites meeting “Constrained Redevelopment Site” conditions defined in the applicable permit, the following runoff reduction option is allowed as a control measure (again, using language in COR070000 for simplicity):

*Infiltrate, evaporate, or evapotranspire, through practices such as green infrastructure, a quantity of water equal to 30% of what the calculated WQCV would be if all impervious area for the applicable redevelopment site discharged without infiltration.*

Under Regulation 72, stormwater quality control measures are also required at smaller developments for applicable development or redevelopment sites adding 500 square feet or more

## Runoff Reduction Field Monitoring in Cherry Creek Basin

---

of impervious area up to the Tier 3 disturbance threshold of one acre.<sup>4</sup> Runoff-reduction related options for meeting Tier 2 stormwater control requirements include the Tier 3 control measure options, as well as the following:

*Incorporate receiving pervious areas that are designed to infiltrate at least 60% of the WQCV for the added or increased impervious area. Such practices minimize directly connected impervious areas by reducing unnecessary impervious areas and routing runoff from impervious surfaces over permeable areas to reduce runoff rates and volumes. Where feasible, natural areas should be protected from disturbance and used for this purpose.*

or

*Demonstrate that an alternative CM or site condition provides nutrient load reduction that is as least as protective as one or more of the criteria [...].*

For all Tier 2 and Tier 3 projects within Stream Preservation Areas (e.g., areas in and near Cherry Creek State Park and within 100-year floodplains of Cherry Creek tributaries), this additional requirement applies:

*[...] post-construction control measures shall be selected and implemented to require owners to select and implement CMs that promote filtration and/or infiltration processes to treat the WQCV or meet runoff reduction design standards for all Tier 2 and Tier 3 new development and redevelopment within the Stream Preservation Area.*

Variations of the above requirements are also included in the 2012 version of Regulation 72, which is still applicable to some of the MS4 permits in the basin. For simplicity, the 2012 requirements are not summarized in this report; however, some of the 2012 variations of runoff reduction are discussed briefly in the context of SEMSWA's MS4 permit later in this report.

Lastly, stormwater management must be performed in accordance with Colorado water rights. Colorado Revised Statute §37-92-602(8) requires any "infiltration facility" to continuously release or infiltrate at least 97% of all of the runoff from a rainfall event that is less than or equal to a 5-year storm within 72 hours after the end of the event.

---

<sup>4</sup>CR 72 defines "Tier 2 development and redevelopment" as land disturbance that results in greater than 500 square feet of impervious area for new development or more than 500 square feet of increased impervious area for redevelopment and disturbs less than one acre of land and is not part of a larger common plan or development or sale that disturbs one acre or more.

### 2.2 Criteria and Methods for Designing and Evaluating Receiving Pervious Areas

#### 2.2.1 MHFD

Volume 3 of MHFD's Urban Storm Drainage Criteria Manual (USDCM) includes design criteria for applying grass buffers and grass swales as RPAs. Design criteria that are relevant to this Project include the following:

- Underdrains are recommended in grass swales where longitudinal slopes are less than 2%.
- Check dams are recommended to be used in grass swales where slopes are steep, primarily to limit flow velocities.
- There is no minimum length recommended for grass buffers, however, buffer slopes should be kept between 2 – 33% and runoff distributed uniformly across the RPA.

Volume 3 also outlines methodology for calculating the runoff reduction performance of RPAs based on soil type, precipitation depth, the UIA, and the RPA, among other parameters. The methods were developed using EPA Stormwater Management Model (SWMM) simulations of various configurations of UIA draining to various configurations of RPA. Table 1 provides a quick reference for sizing RPA based on these methods, however, each site must be evaluated individually if RPAs will be used to demonstrate runoff reduction performance for regulatory purposes. MHFD's SCM Design workbook can be used to make these calculations for specific sites.

MHFD's runoff reduction methodology cannot be applied to grass swales with underdrains. The current methodology is based on modeling that did not consider grass swales with underdrains.

The USDCM does not provide design criteria for infiltration basins, however they are commonly used in other parts of the country. Infiltration basins (not to be confused with "full-infiltration" variations of other infiltration-based SCMs) are ground depressions/excavations where runoff is collected and infiltrated. Where appropriate conditions exist, infiltration basins can be constructed with minimal grading work especially where natural ground depressions exist, and existing soils allow for infiltration.

## Runoff Reduction Field Monitoring in Cherry Creek Basin

**Table 1. Quick reference sizing for RPAs, including grass buffers**  
(Source: MHFD 2024 USDCM Volume 3, Chapter 4)

| HSG | REQUIRED UIA:RPA RATIO <sup>1</sup> |                     |
|-----|-------------------------------------|---------------------|
|     | 60% WQCV REDUCTION                  | 100% WQCV REDUCTION |
| A   | 7.2:1                               | 3.7:1               |
| B   | 3.4:1                               | 1.9:1               |
| C/D | 2:1                                 | 1:1                 |

<sup>1</sup>Based on WQCV precipitation of 0.6 inches and slopes up to 33%.

### 2.2.2 SEMSWA

SEMSWA’s Stormwater Management Manual includes design criteria applicable to its jurisdiction. In general, SEMSWA references the USDCM, Volume 3 for the design and evaluation of RPAs. However, the SEMSWA Manual includes additional criteria for RPAs and runoff reduction. Portions of Chapter 14 of the SEMSWA Manual relevant to this Project are paraphrased below.

- Similar to MHFD, SEMSWA does not allow for underdrained SCMs to meet the Runoff Reduction Standard.
- The use of grass buffers and swales requires appropriate analysis of existing soils and application of soil amendments, if necessary.
- Grass buffers and swales must be vegetated with sod or turf-forming native grasses. No cobble, mulch, or other landscaping materials can be used within these SCMs.
- For all Tier 2 new development and redevelopment projects within the Cherry Creek Reservoir Basin, SCMs are required to meet one of several “water quality enhancements” in accordance with the 2012 version of Regulation 72. Those options include:
  - Runoff is discharged as sheet flow across a Grass Buffer.
  - Runoff is discharged from the site through a Grass Swale in combination with implementation of Minimized Directly Connected Impervious Area (MDCIA) practices.
  - Runoff is discharged across undisturbed and vegetated land a minimum distance of 50 feet or three times the distance criteria for Grass Buffers, whichever is greater, with a slope not exceeding 4% over that distance.



### 3.0 PROJECT OBJECTIVES

The overarching objective of this Project is to improve understanding of the runoff reduction performance of RPAs through field monitoring, specifically within the Cherry Creek Reservoir Basin. Achieving this objective will provide valuable data and information to continue improving design criteria and computational methods for RPAs and potentially inform future permit requirements. Specific objectives and research questions directing this Project include:

1. Determine if underdrained grass swales provide any runoff reduction benefits and if so, how much? This would help validate (or invalidate) existing criteria that do not allow for runoff reduction benefits to be calculated for underdrained systems.
2. Determine precipitation thresholds that generate underdrain discharge. If, for example, underdrains do not produce discharge during certain events, such data could be extrapolated to estimate average annual runoff reduction.
3. Evaluate grass buffer performance against existing criteria. Do results generally conform with UIA:RPA ratios recommended by MHFD? Do results support SEMSWA's minimum buffer distance of 50 feet (from the 2012 Regulation 72)?
4. Evaluate if "minimally-engineered" infiltration basins could be used within the Basin to meet various infiltration requirements. Notably, neither MHFD nor SEMSWA provide criteria or guidance for using infiltration basins as RPAs. While not currently considered as a formal SCM in the USDCM, infiltration basins do meet the broader definition of a receiving pervious area and are considered as such for purposes of this study. Bioretention cells and sand filters (with full-infiltration designs) are somewhat representative of infiltration basins; however, design criteria for bioretention cells are more extensive, including defined inlet and outlet structures and the potential need for importing filter media. Many areas within the Basin have relatively sandy surface soils that may meet the gradation and nutrient limits specified in the USDCM and thus would not require special filter media, and infiltration basins (by definition) would not require outlet structures.
5. For all of the above, if results vary among different sites, understand what major factors may dictate results.

### 4.0 METHODS AND MONITORING SITES

WWE used two primary monitoring methods to evaluate runoff reduction across nine different sites: simulated runoff tests (SRTs) and ambient monitoring. A summary of the methods is provided in this section, with site-specific details provided in subsequent sections of this report.

SRTs involved applying known rates and volumes of water to RPAs with access to nearby fire hydrants. The primary benefit of using the SRT approach is that inflows can be measured with higher accuracy compared to rainfall/runoff model estimates. A drawback of SRTs is that rates

## Runoff Reduction Field Monitoring in Cherry Creek Basin

---

and volumes of inflows are limited by hydrant capacity and water usage<sup>5</sup>, and therefore may not always be capable of testing RPAs at the same rates and volumes that would occur for typical storm events.

SRTs were conducted at four underdrained grass swales, two non-engineered<sup>6</sup> grass/vegetated buffers and one non-engineered infiltration basin. Outflows from the grass swale underdrains were measured using weir boxes (as described in Appendix 1) and pressure transducers. Outflows (i.e., infiltration rates) from the buffers and infiltration basin were calculated based on the measured extent of wetted area, the duration of the test, and staff gauge readings (for the infiltration basin only).

“Ambient” monitoring methods were used to evaluate RPA performance from actual storm events. These methods were not intended to generate runoff reduction results based on measured inflows and outflows, but instead were used to qualitatively evaluate RPA performance based on rainfall metrics. Ambient monitoring was performed at four underdrained grass swales (same as above), one “minimally-engineered<sup>7</sup>” infiltration basin and one “minimally-engineered” grass swale/infiltration basin system.

Precipitation data for ambient monitoring were obtained from MHFD’s Gage-Adjusted Radar Rainfall (GARR) program. The GARR program estimates rainfall depths for 1 km<sup>2</sup> grid cells across the Denver metro region at 5-minute intervals. GARR does have some limitations for areas where rain gages are not available for estimated precipitation. The grass swale underdrains were monitored using time-lapse photographs of the underdrains, combined with pressure transducer data in the underdrain weir boxes, to indicate the presence or absence of underdrain discharge during each storm event. The infiltration basins were monitored using game camera time-lapse photographs of a staff gauge installed within the infiltration basins to indicate presence or absence of ponded water and estimate infiltration rates.

Table 2 summarizes the monitoring sites and methods used at each site for this Project.

---

<sup>5</sup> Field staff were considerate in not using unreasonable volumes of water that could be perceived as being wasteful.

<sup>6</sup> These sites were not “engineered” buffers/infiltration basins but were selected for monitoring due to being representative of such systems when left relatively undisturbed. Additional details of each site are provided later in this report.

<sup>7</sup> These sites were designed and constructed with some minimal grading work and import of filter media. Additional details of each site are provided later in this report.

## Runoff Reduction Field Monitoring in Cherry Creek Basin

**Table 2. Summary of monitoring sites and methods used at each site**

| <b>Monitoring Site</b> | <b>RPA Type</b>                       | <b>Design Type</b>   | <b>SRT Monitoring</b> | <b>Ambient Monitoring</b> |
|------------------------|---------------------------------------|----------------------|-----------------------|---------------------------|
| SEMSWA                 | Grass Swale (underdrained)            | Engineered           | X                     | X                         |
| RoadSafe               | Grass Swale (underdrained)            | Engineered           | X                     | X                         |
| Central Centennial     | Grass Swale (underdrained)            | Engineered           | X                     | X                         |
| Smith & Smith          | Grass Swale (underdrained)            | Engineered           | X                     | X                         |
| Mountain Loop (CCSP)   | Swale/Infiltration Basin <sup>1</sup> | Minimally Engineered |                       | X                         |
| Lake Loop (CCSP)       | Infiltration Basin                    | Minimally Engineered |                       | X                         |
| 17 Mile – Inf          | Infiltration Basin                    | Non-engineered       | X                     |                           |
| 17 Mile – Buf          | Vegetated Buffer                      | Non-engineered       | X                     |                           |
| Parker – Buf           | Vegetated Buffer                      | Non-engineered       | X                     |                           |

<sup>1</sup>Infiltration basins are not included as formal SCMs in the USDCM

## **5.0 GRASS SWALES (UNDERDRAINED)**

This section presents monitoring work and results for four grass swales, all of which have underdrains and are located within the Basin and SEMSWA’s jurisdiction.

### **5.1 Methods**

The following methods apply to all grass swales, except where described in the site-specific sections of this report.

#### **5.1.1 Simulated Runoff Tests (SRTs)**

##### **5.1.1.1 Inflow Rate and Volume**

The source of inflow for each SRT was a fire hydrant located within 50-100 feet of the swale. A flow meter and discharge valve connected the fire hydrant to a fire hose to control and measure the rate and volume of inflow. Prior to the beginning of each SRT, SEMSWA staff adjusted the discharge valve on the flow meter as close as possible to the target inflow rate. In most cases, the inflow rate was held constant throughout each test. If adjustments were made during the test, field staff recorded the new inflow rate and time that adjustments were made. Total inflow volumes were measured by recording the flow meter volume at the start and end of each SRT. During the SRT, the fire hose directed inflow near the top (upstream end) of the swale.

##### **5.1.1.2 Surface Flow (“Wetted Length”) Measurements**

The distance of surface flow from the inflow location was measured using a tape measure every few minutes throughout the duration of the SRT. These measurements were important to understand how much of the swale was “wetted” during the SRT. The greater the distance that the swale was wetted, the greater the area of the swale was available to absorb and infiltrate runoff.

The distance of surface flow was also monitored as a control for the duration of the SRT. If the surface flow started to approach the full length of the swale, the inflow was shut off to avoid overflows into other swales or the outlet structure where outflows could not be measured. Additionally, if the surface flow reached a point where it was no longer increasing along the length of the swale, the inflow was stopped. This latter control was an indication that a point of equilibrium was reached, where inflows equaled outflows.

##### **5.1.1.3 Underdrain Outflow Rate and Volume**

Outflow from the underdrains was measured using a 90-degree V-notch weir at the SEMSWA, Central Centennial, and Smith & Smith sites, and a rectangular weir at the RoadSafe site. A pressure transducer was installed in each weir box. The pressure transducers were programmed to record readings every 60 seconds or less and were downloaded within 24 hours of the end of the SRT. The 90-degree V-notch weir can measure a range of discharges from 2 – 292 gallons per minute (gpm), while the rectangular weir box can measure a range of discharges from 36 – 388 gpm. Design drawings and rating curves for both weirs are included in Appendix 1.

## Runoff Reduction Field Monitoring in Cherry Creek Basin

---

Using the pressure transducer data, the instantaneous outflow rate from the weir box was calculated using the following equation for the 90-degree V-notch weirs:

$$\text{Outflow Rate (gpm)} = 2.4022D^{2.4636}$$

Where D is the depth of the water (inches) above the bottom of the V-notch weir.

The discharge equation for the rectangular weir box is:

$$\text{Outflow Rate (gpm)} = 36.018D^{1.4739}$$

The instantaneous outflow rates computed for each time interval were summed to determine the total outflow volume for the entire SRT.

### 5.1.1.4 Runoff Reduction Calculations

Runoff reduction (in terms of volume) was calculated using the following equation:

$$\text{Runoff Volume Reduction (\%)} = \frac{\text{Inflow Volume (gal)} - \text{Outflow Volume (gal)}}{\text{Inflow Volume (gal)}} * 100$$

Runoff reduction (in terms of peak flow) was calculated using the following equation:

$$\text{Peak Flow Runoff Reduction (\%)} = \frac{\text{Max. Inflow Rate (gpm)} - \text{Max. Outflow Rate (gpm)}}{\text{Max. Inflow Rate (gpm)}} * 100$$

### 5.1.2 Ambient Monitoring

Ambient monitoring was performed to assess the presence and absence of underdrain discharge during storm events.

Cameras were installed in the outlet structure of each grass swale to record photographs of the underdrain/weir box every 5 minutes, 24 hours per day. The cameras were installed on May 19, 2023 and remained in place through November 1, 2023.

GARR data were used to identify storm events at each of the sites through October 19, 2023, the last date of available GARR data for 2023. For each storm event that exceeded 0.1 inches in total depth, the following metrics were computed using the USGS Rainmaker<sup>8</sup> R Code program:

- Total precipitation depth (inches)
- Total precipitation duration (hours)
- Maximum 5-minute intensity (in/hr)
- Maximum 60-minute intensity (in/hr)

---

<sup>8</sup> <https://code.usgs.gov/water/analysis-tools/Rainmaker>



For each GARR-indicated storm event, the camera images taken 30 minutes prior to the start of precipitation and two hours after the end of precipitation were reviewed.

### 5.2 SEMSWA

#### 5.2.1 Introduction

The SEMSWA office, located at 7437 S. Fairplay St. in Centennial, has an on-site demonstration RPA equipped with underdrains (Figure 1). The RPA was installed in 2015 and consists of three bioswales.<sup>9</sup> A concrete forebay level spreader is installed where runoff from the adjacent parking lot enters the RPA. The RPA receives a higher-than-average level of maintenance, with regular irrigation and vegetation maintenance.

The design drawings for the SEMWA demonstration RPA do not include WQCV or contributing area calculations; therefore, WWE estimated the contributing area at 0.85 acres using Google Earth (Figure 1) with an assumed 100% imperviousness. The southeastern bioswale was selected for monitoring because its underdrain is isolated from the other two bioswale underdrains. It is approximately 105 feet long, is well-vegetated with a variety of tall grasses, and has the characteristics indicated in Table 3. The estimated UIA:RPA ratio for this bioswale is 24:1 assuming the bioswale receives 1/3 of the runoff from the contributing area.<sup>10</sup>

---

<sup>9</sup> We use “bioswale” instead of grass swale for this site because the swales are vegetated with various non-turfgrass plants and contain engineered soils.

<sup>10</sup> UIA = 0.85/3 acres (12,342 ft<sup>2</sup>) and RPA = 105 ft \* 5 ft (525 ft<sup>2</sup>).

Table 3. Characteristics of SEMSWA southeast bioswale

| SCM Characteristics                                  |  |
|--|--|
| Infiltration Material<br>(top layer to bottom layer) | 6" growing media<br>6" Class C<br>3" Class B<br>3" Class A<br>Underdrain<br>3" Class A<br>Geotextile |
| Underdrain   | Slotted  |
| Underdrain Diameter (in)                             | 4  |
| Approximate Length (ft)                              | 105  |
| Approximate Width (ft)                               | 5  |
| Side Slopes (H:V)                                    | ~6   |
| Channel Slope  | Unknown  |
| Estimated UIA:RPA                                    | 24:1   |

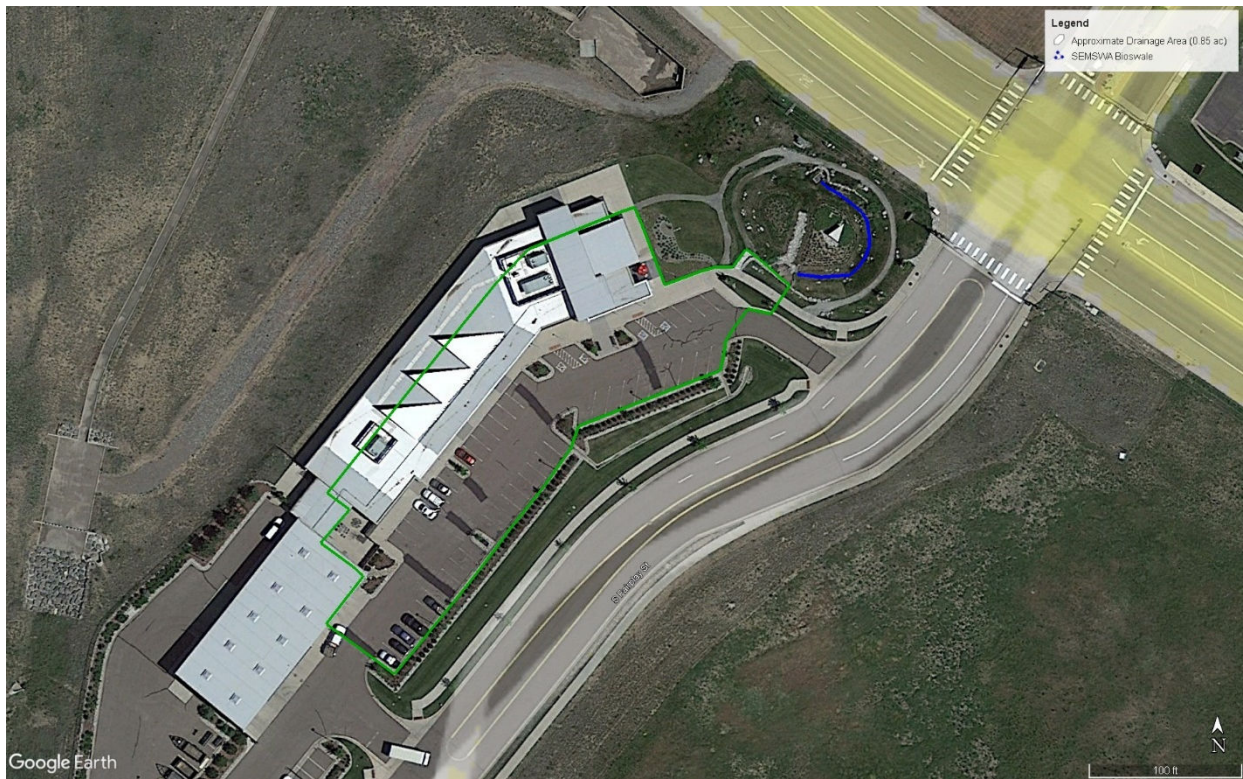

Figure 1. SEMSWA office with southeast swale and contributing area

### 5.2.2 Summary of SRTs

Four SRTs were completed at the SEMSWA bioswale site from September through October 2023 (Table 4). The range of inflow volumes tested varied from 3,000 – 4,100 gallons and were selected to be representative of the WQCV for the contributing area divided by three (i.e., approximately

## Runoff Reduction Field Monitoring in Cherry Creek Basin

3,800 gallons), assuming the forebay evenly distributes runoff to each of the three bioswales. The range of inflow rates was selected to represent different rainfall/runoff intensities. The SRT inflow durations ranged from approximately 15–30 minutes.

**Table 4. Summary of SRTs performed at the SEMSWA bioswale**

| Date               | Inflow Rate (gpm) | Inflow Volume (gal) | Inflow Duration (min) |
|--------------------|-------------------|---------------------|-----------------------|
| September 6, 2023  | 240               | 3,000               | 13                    |
| September 18, 2023 | 100               | 3,100               | 31                    |
| September 26, 2023 | 200               | 4,100               | 20                    |
| October 5, 2023    | 160               | 3,900               | 25                    |

A few minor issues were observed by field staff and are described below; however, WWE does not believe that these issues are significant enough to meaningfully change the overall results.

1. Some leaking from the bottom of the underdrain was noted. Field observations estimate the unmeasured discharge to be 2 gpm (Figure 2).



**Figure 2. Leaking from the bottom of the underdrain during SRT**

2. Some leakage from the irrigation system was noted during the SRTs adding unmeasured inflow to the swale (Figure 3), however, the rate and volume was relatively minor compared to the SRT inflows.





**Figure 3. Leaking from irrigation system**

3. Prior to performing the SRTs, SEMSWA staff installed solid caps on three underdrain cleanouts that previously had slotted caps. A fourth cleanout was discovered during the September 6 SRT at approximately 74 feet down the length of the swale that had a slotted cap at ground level (Figure 4). Surface flow was observed draining into the slotted opening at an approximate rate of 5 gpm, based on visual observations by field staff. The cleanout cap was plugged with duct tape for subsequent SRTs.



**Figure 4. Fourth cleanout discovered during September 6, 2023 SRT**

**5.2.3 SRTs – Results and Discussion**

The total inflow volume for the four SRTs ranged from 3,000 – 4,100 gallons, and the total outflow ranged from 2,000 – 2,600 gallons (Figure 5). The runoff volume reduction observed for the four SRTs ranged from approximately 20 – 40% (Figure 5 and Figure 6). The lowest volume reduction of 21% occurred during the first SRT, with the smallest inflow volume (3,000 gallons) applied at the highest inflow rate (240 gpm). The greatest volume reduction (40%) was observed during the fourth SRT, with an inflow volume of 3,900 gallons at a rate of 160 gpm.

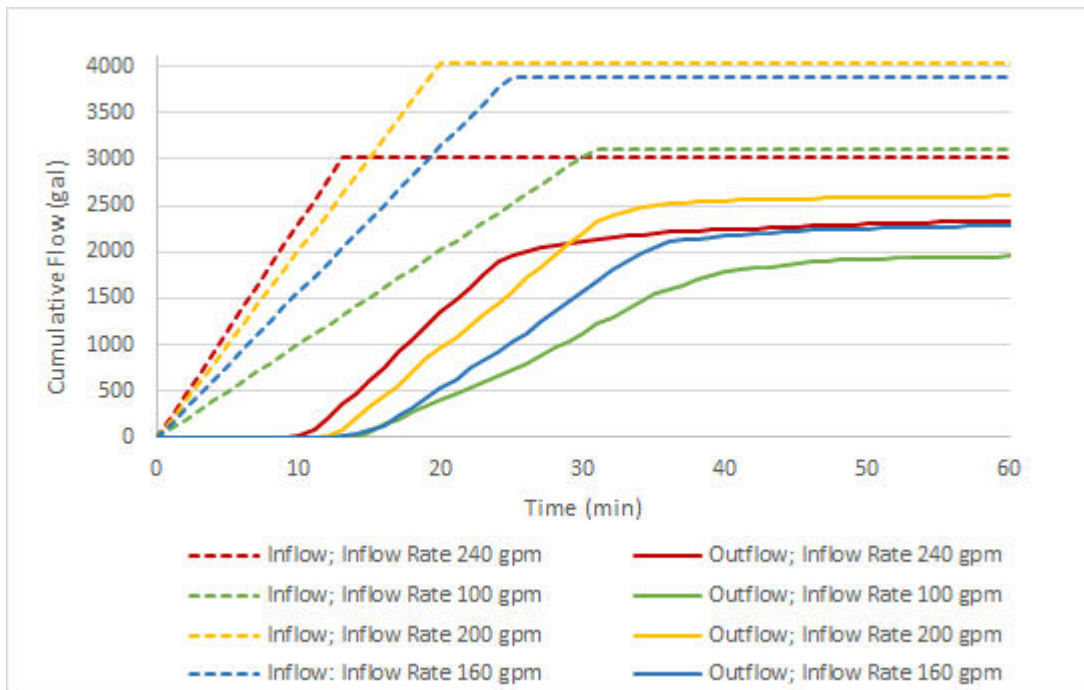

**Figure 5. Cumulative inflow and outflow volumes for SRTs at the SEMSWA site**



## Runoff Reduction Field Monitoring in Cherry Creek Basin

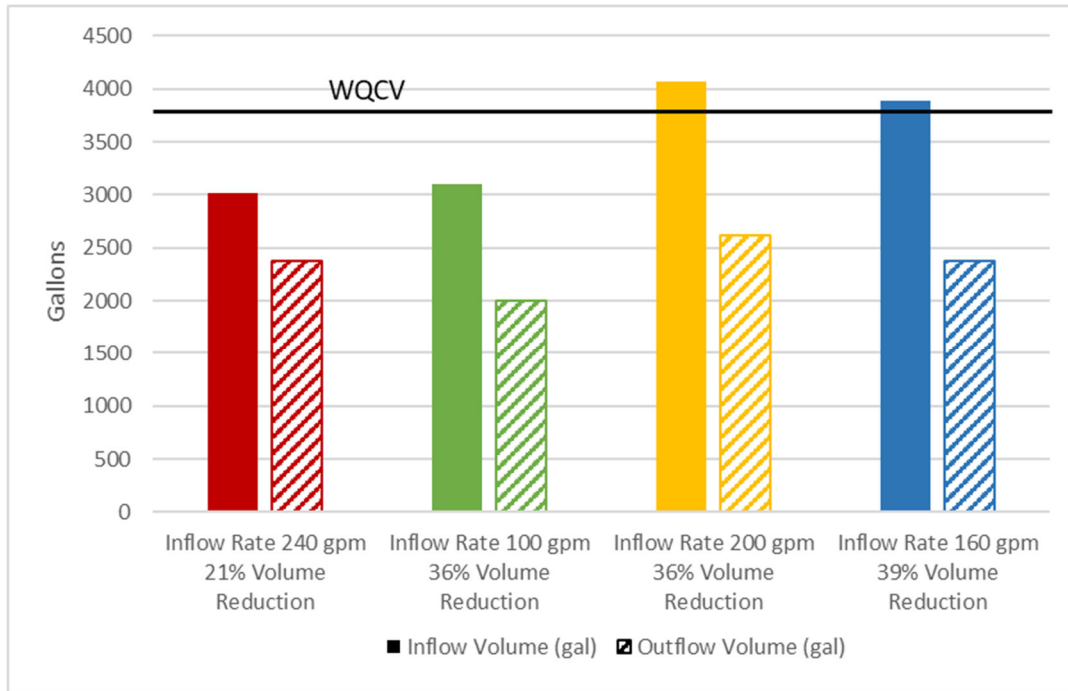

**Figure 6. Volume reduction observed for SRTs at the SEMSWA site**

The maximum inflow rate varied between 100 – 240 gpm for each of the SRTs, and the peak outflow rate varied between 98 – 170 gpm (Figure 7). The reduction in peak flow rate ranged from 3 – 30% (Figure 7 and Figure 8).

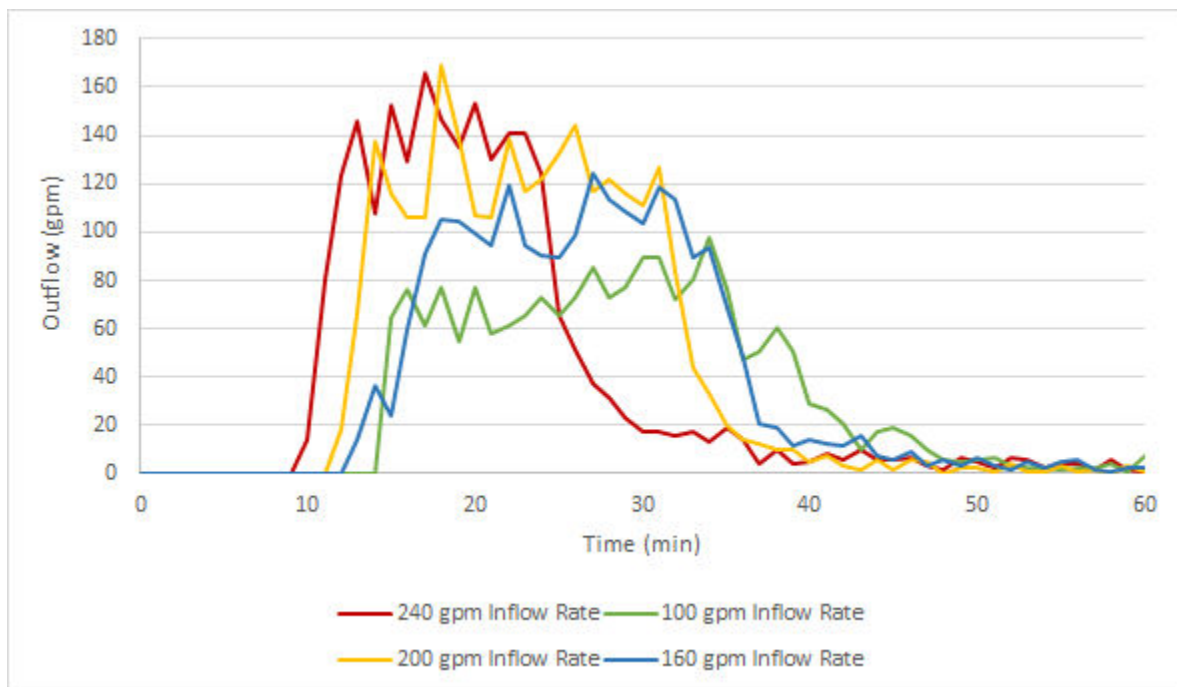

**Figure 7. Instantaneous weir outflow during SRTs at the SEMSWA site**

## Runoff Reduction Field Monitoring in Cherry Creek Basin

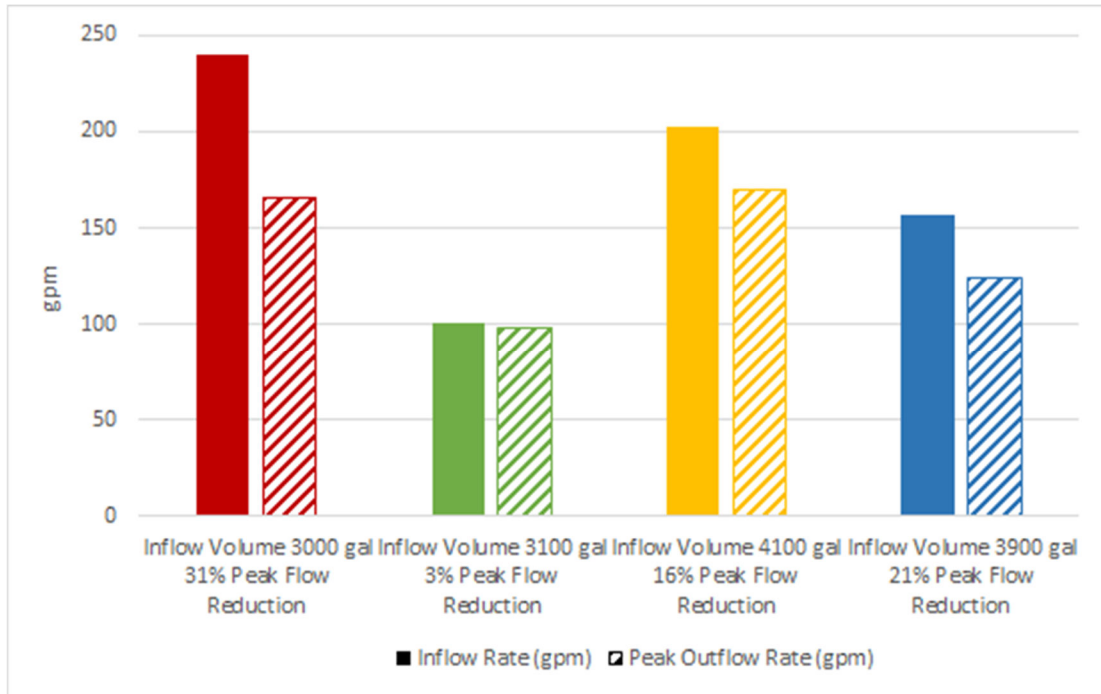
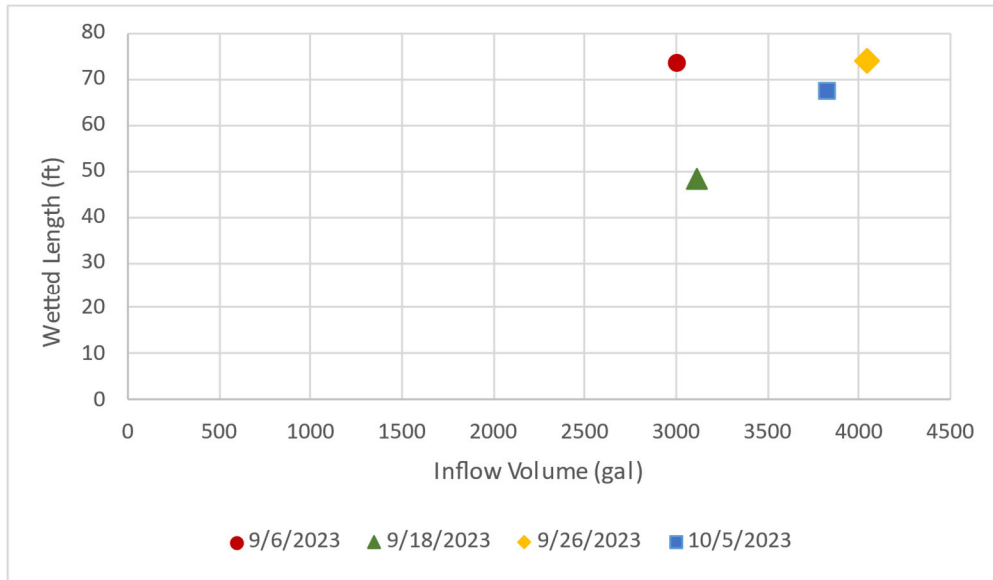

**Figure 8. Peak flow reduction observed at SEMSWA SRTs**

The maximum wetted length varied between approximately 48 – 74 feet (Figure 9 and Figure 10) for each SRT. The shortest wetted length (48 feet) occurred during the SRT using the lowest inflow rate (100 gpm) and the longest wetted length (73 – 74 feet) occurred during the SRTs with the highest inflow rates (200 – 240 gpm). As discussed in the section above, the test using the 240-gpm inflow rate was shut off once surface flow was observed entering the uncapped underdrain located at 74 feet. It is likely the wetted length for this test would have been higher if the test had continued and been allowed to reach equilibrium.

The results also do not indicate an obvious relationship between inflow volume and wetted length. Taken all together, these results are consistent with expectations and theory, with larger inflow rates resulting in greater wetted swale lengths.

## Runoff Reduction Field Monitoring in Cherry Creek Basin



**Figure 9. Wetted length and total inflow volume during SRTs at the SEMSWA site**

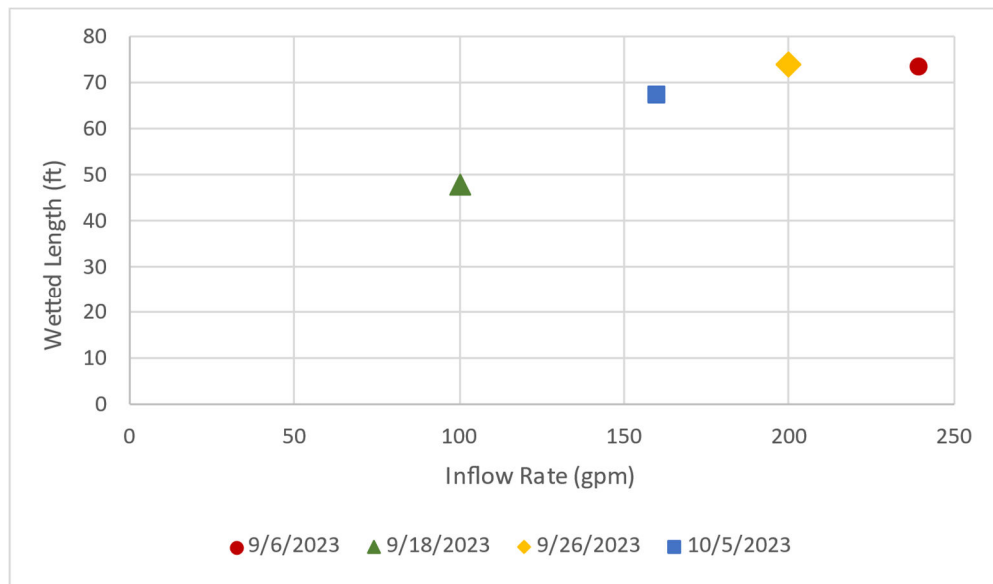

**Figure 10. Wetted length and inflow rate during SRTs at SEMSWA site**

Table 5 summarizes the SRT results. As noted above, the inflow volumes were representative of the WQCV for the contributing area divided evenly among the three bioswales at the site (3,800 gallons). The results demonstrate that the bioswales provide measurable runoff volume reduction, but not enough to meet the Runoff Reduction Standard (60% of the WQCV).

---

## Runoff Reduction Field Monitoring in Cherry Creek Basin

---

**Table 5. Runoff volume and peak flow reduction measured during SRTs at the SEMSWA site**

| <b>Date</b> | <b>Inflow Rate (gpm)</b> | <b>Peak Outflow Rate (gpm)</b> | <b>Inflow Volume (gal)</b> | <b>Outflow Volume (gal)</b> | <b>Runoff Volume Reduction (%)</b> | <b>Peak Flow Reduction (%)</b> |
|-------------|--------------------------|--------------------------------|----------------------------|-----------------------------|------------------------------------|--------------------------------|
| 9/6/2023    | 240                      | 170                            | 3,000                      | 2,400                       | 21                                 | 31                             |
| 9/18/2023   | 100                      | 98                             | 3,100                      | 2,000                       | 36                                 | 3                              |
| 9/26/2023   | 200                      | 170                            | 4,100                      | 2,600                       | 36                                 | 16                             |
| 10/5/2023   | 160                      | 120                            | 3,900                      | 2,400                       | 39                                 | 21                             |

### **5.2.4 Ambient Monitoring – Results and Discussion**

Twenty-seven precipitation events of at least 0.1 inches depth occurred at the SEMSWA site during the monitoring period. Outflow was observed from the underdrain for all precipitation events (Table 6).

## Runoff Reduction Field Monitoring in Cherry Creek Basin

**Table 6. Underdrain discharge presence/absence in response to precipitation events at the SEMSWA site**

| Precipitation Event Start Date | Precipitation Event Metrics |                |                            |                             | Weir Flow (Present, Absent) |
|--------------------------------|-----------------------------|----------------|----------------------------|-----------------------------|-----------------------------|
|                                | Depth (in)                  | Duration (hrs) | 5-minute Intensity (in/hr) | 60-minute Intensity (in/hr) |                             |
| 6/2/2023                       | 0.11                        | 1.4            | 0.2                        | 0.1                         | Present                     |
| 8/25/2023                      | 0.11                        | 3.3            | 0.3                        | 0.1                         | Present                     |
| 10/11/2023                     | 0.13                        | 6.7            | 0.4                        | 0.1                         | Present                     |
| 6/12/2023                      | 0.13                        | 2.4            | 0.1                        | 0.1                         | Present                     |
| 8/2/2023                       | 0.13                        | 6.2            | 0.2                        | 0.1                         | Present                     |
| 8/1/2023                       | 0.17                        | 2.2            | 0.5                        | 0.1                         | Present                     |
| 9/3/2023                       | 0.18                        | 6.3            | 0.5                        | 0.1                         | Present                     |
| 9/14/2023                      | 0.24                        | 8.3            | 0.6                        | 0.2                         | Present                     |
| 6/11/2023                      | 0.25                        | 10.5           | 0.4                        | 0.1                         | Present                     |
| 8/6/2023                       | 0.25                        | 5.8            | 0.9                        | 0.2                         | Present                     |
| 7/7/2023                       | 0.27                        | 6.3            | 1.5                        | 0.2                         | Present                     |
| 8/27/2023                      | 0.31                        | 6.7            | 1.1                        | 0.3                         | Present                     |
| 8/8/2023                       | 0.32                        | 0.5            | 1.5                        | 0.3                         | Present                     |
| 9/10/2023                      | 0.36                        | 16.3           | 0.3                        | 0.1                         | Present                     |
| 5/26/2023                      | 0.37                        | 1.3            | 2.1                        | 0.4                         | Present                     |
| 6/5/2023                       | 0.37                        | 7.1            | 0.8                        | 0.3                         | Present                     |
| 6/15/2023                      | 0.41                        | 3.8            | 0.4                        | 0.2                         | Present                     |
| 6/16/2023                      | 0.55                        | 12.3           | 0.3                        | 0.1                         | Present                     |
| 7/31/2023                      | 0.55                        | 8.3            | 0.6                        | 0.2                         | Present                     |
| 6/3/2023                       | 0.58                        | 18.0           | 0.4                        | 0.2                         | Present                     |
| 6/6/2023                       | 0.59                        | 2.3            | 1.6                        | 0.6                         | Present                     |
| 6/30/2023                      | 0.72                        | 2.1            | 2.5                        | 0.6                         | Present                     |
| 7/4/2023                       | 0.73                        | 11.5           | 3.6                        | 0.5                         | Present                     |
| 7/20/2023                      | 0.94                        | 16.0           | 1.2                        | 0.3                         | Present                     |
| 6/21/2023                      | 1.02                        | 8.8            | 1.5                        | 0.5                         | Present                     |
| 6/8/2023                       | 1.39                        | 4.6            | 2.4                        | 1.3                         | Present                     |
| 6/22/2023                      | 1.42                        | 4.3            | 3.6                        | 1.4                         | Present                     |

The results are somewhat surprising as very small amounts of runoff would be expected with some of the smaller events (e.g., < 0.2 inches), and such small runoff volumes would be expected to simply fill the voids of the swale soils (not infiltrate down to the underdrain). One possible explanation is that the swale receives such frequent irrigation that the soil remains at or near saturation. This explanation is supported by photographs that show underdrain discharge during extended dry periods.

### 5.2.5 Soil Analysis

Two 6-inch depth soil cores (0 – 6” depth and 6 – 12” depth) were collected on November 1, 2023, and sent to the Colorado State University SPUR Soil, Water and Plant Testing Laboratory for full chemical and physical analysis. Soil texture analysis of both samples indicated the media at the SEMSWA site consists of sandy loam soil (Figure 11). The soil gradations are consistent with what was specified in the design drawings (Muller, 2014) and MHFD criteria for bioretention media. The full soils report, including chemical analysis, is included in Appendix 2.

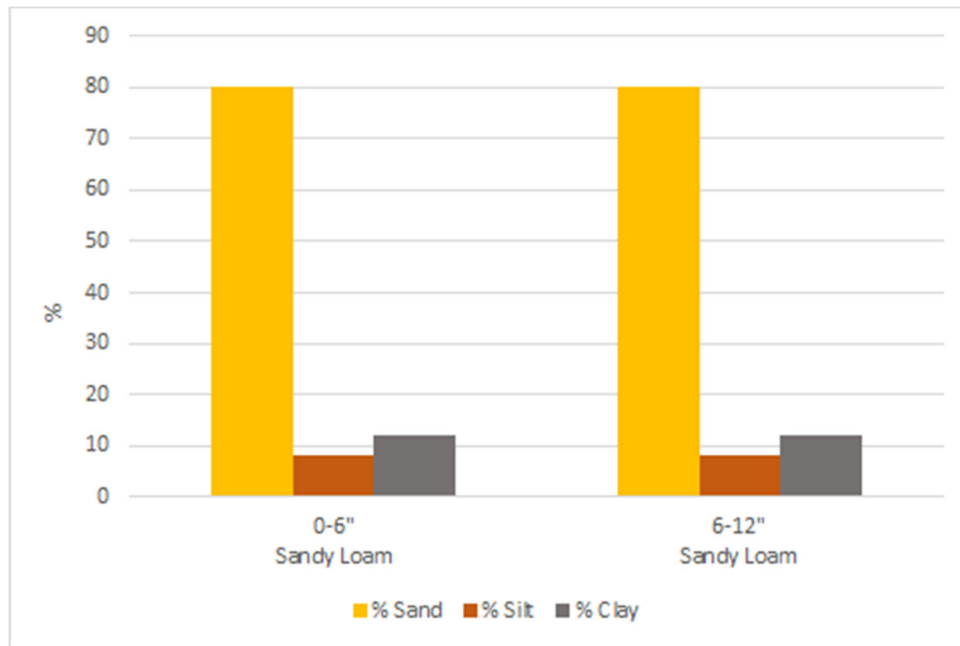

Figure 11. Soil texture analysis of SEMSWA site

## 5.3 RoadSafe

### 5.3.1 Introduction

The RoadSafe Site, located at 7909 S. Chambers Rd. in Centennial, has a combination grass buffer with grass swale designed to meet the SEMSWA 20/10 rule for disconnected impervious area (Figure 12). The buffer/swale was installed in 2018 and receives runoff from an adjacent parking lot and driveway, with the grass buffer between the parking lot/driveway and the swale. There is also an inlet at the upstream side of the swale that discharges runoff from other portions of the site to the swale. Vegetation is turfgrass in fair condition and does not appear to be actively irrigated. The turfgrass is very short (< 1 inch) and there were small areas where vegetation was sparse.

According to the drainage report (CKE Engineering, 2017), the UIA draining to the buffer/swale is approximately 0.97 acres. Of the approximately 4,700 square feet (sf) of RPA, 1,600 sf may be attributed to the grass swale when flowing with discharge from a 2-year event. The swale is



## Runoff Reduction Field Monitoring in Cherry Creek Basin

approximately 167 feet long with a bottom width of 2 feet, 4:1 side slopes, and 0.003 longitudinal slope (Table 7). The estimated UIA:RPA for the grass swale is approximately 122:1.



**Figure 12. RoadSafe site with combination grass buffer and grass swale with red flow direction arrow**  
(Google Earth image)

**Table 7. Design characteristics of RoadSafe grass swale**

| Road Safe SCM Characteristics                   |   |
|---|---|
|   | Grass Swale   |
| Infiltration Material<br>(top to bottom layers) | 6" growing media<br>6" filter media<br>9" drainage media around<br>underdrain |
| Underdrain                                      | Perforated  |
| Underdrain Diameter (in)                        | 4   |
| Approximate Length (ft)                         | 167   |
| Approximate Width (ft)                          | 2   |
| Side Slopes (H:V)                               | 4   |
| Design Slope                                    | 0.003   |
| Design UIA:RPA                                  | 9:1   |
| Field-Estimated UIA:RPA of Swale                | 122:1   |

## Runoff Reduction Field Monitoring in Cherry Creek Basin

### 5.3.2 SRT Summary

Four SRTs were completed at the RoadSafe site with inflow rates varying between 45 – 110 gpm and total inflow volumes between 400 – 1,400 gallons (Table 8).

**Table 8. Summary of SRTs performed at RoadSafe grass swale**

| Date               | Inflow Rate (gpm) | Inflow Volume (gal) | Outflow Volume (gal) | Inflow Duration (min) |
|--------------------|-------------------|---------------------|----------------------|-----------------------|
| September 6, 2023  | 110               | 1,400               | Minimal <sup>1</sup> | 13                    |
| September 18, 2023 | 45                | 400                 | 0                    | 9                     |
| September 26, 2023 | 55                | 900                 | Minimal              | 16                    |
| October 5, 2023    | 50                | 1,200               | Minimal              | 23                    |

<sup>1</sup> A very small amount of discharge was observed through the underdrain but could not be accurately measured.

#### 5.3.2.1 SRT 1 – September 6, 2023

The first SRT was performed using an inflow rate of 110 gpm and total inflow volume of approximately 1,400 gallons. The inflow rate was set to be representative of the WQCV occurring over approximately 35 minutes. The total inflow volume was much lower than the WQCV because the inflow extended along the length of the swale more rapidly than expected and inflow was shut off once it was apparent the entire length of the swale would be wetted. Inflow overtopped into the outlet structure, despite having sandbags placed around it. Field observations suggested little (if any) outflow through the underdrain. Due to flow overtopping into the outlet structure and limited underdrain outflow, total outflow rates and volumes could not be measured.

The results of this SRT were clearly not as expected and did not produce quantitative runoff reduction results. However, additional SRTs were conducted with various modifications, as discussed below.

#### 5.3.2.2 SRT 2 – September 18, 2023

This SRT was conducted with the objective of estimating the minimum inflow rate and/or inflow volume that could be discharged into the swale without the inflow exceeding the length of the swale.

Inflow was discharged at a much lower rate (45 gpm) than the first SRT. Inflow was stopped once the wetted length reached approximately 66 feet (46% of the total swale length) to avoid overflow into the outlet box. The total volume of inflow was approximately 400 gallons. The wetted length ultimately extended to approximately 100 feet (i.e., no overflow into the outlet box) and there was not any measurable outflow from the underdrain.

The results of this SRT demonstrate that the swale can provide at least 400 gallons of runoff reduction during relatively low-intensity rainfall/runoff events.



### 5.3.2.3 SRT 3 – September 26, 2023

This SRT was conducted with the objective of determining how sandbags placed end to end (check dams) within the swale could increase runoff reduction (Figure 13). For this SRT, sandbags were placed across the swale at locations approximately 25 feet, 50 feet, and 75 feet downstream of the inflow location (Figure 14). The inflow rate was set at 55 gpm and inflow was shut off once the surface flow reached 75 feet, for a total inflow volume of 900 gallons. Inflow continued to extend to approximately 105 feet and did not overflow into the outlet box. A small amount of discharge was visible through the underdrain, however, it was too small to accurately measure. The results of this SRT demonstrated that the swale could capture and infiltrate at least double the inflow from the second test (400 gallons infiltrated) by implementing relatively simple check dam retrofits.



**Figure 13. Two sandbags placed end to end functioned as check dams during the third and fourth SRTs at RoadSafe**



**Figure 14. Three sandbag check dams placed at 25, 50, and 75 feet down the length of the grass swale during the third SRT at RoadSafe**

#### **5.3.2.4 SRT 4 – October 5, 2023**

This SRT was conducted with the objective of further evaluating how check dams placed within the swale could increase runoff reduction. Based on results from the previous SRT, additional sandbags were placed approximately 100 feet downstream of the inflow location. Therefore, this SRT was conducted with sandbag check dams at 25 feet, 50 feet, 75 feet, and 100 feet downstream of the inflow location (Figure 15).



**Figure 15. Four sandbag check dams installed at 25, 50, 75, and 100 feet down the length of the grass swale during the fourth SRT at RoadSafe**

The inflow rate was set at 50 gpm and inflow was shut off once the surface flow reached approximately 110 feet from the inflow location. The total inflow volume was approximately 1,200 gallons and there was no outflow measured in the underdrain. A small discharge from the underdrain was captured by the photos occurring approximately one hour after the start of the SRT and continuing for almost three hours but was not measured.

### **5.3.2.5 SRT - Results and Discussion**

Starting with the first SRT, it was apparent the swale had very little infiltration capacity as the inflow rapidly moved down the swale. We attempted to apply an inflow volume equivalent to the WQCV (3,750 gallons) but had to stop the inflow at a total volume of 1,400 gallons once it was apparent the inflows would reach the outlet structure. At the applied inflow rate of 110 gpm, the swale could not retain and infiltrate even 35% of the WQCV.

Results of the second SRT showed the swale could retain and infiltrate at least 400 gallons, which is only 10% of the WQCV. No discharge was observed from the underdrain.

Results of the third and fourth SRTs demonstrated the ability of check dams to improve the runoff reduction performance of the swale. By placing a series of sandbag check dams along the swale, inflow volumes of 900 gallons and 1,200 gallons could be retained and infiltrated. This was an increase of about 100% and 200%, respectively, compared to the SRT without any check dams. Even so, the inflow volumes were still only 25% and 35% of the WQCV.

The lack of underdrain discharge during the SRTs was noted. Additional discussion on this issue is provided below.

## Runoff Reduction Field Monitoring in Cherry Creek Basin

### 5.3.3 Ambient Monitoring – Results and Discussion

Twenty-seven precipitation events of at least 0.1 inches depth occurred at the RoadSafe site during the monitoring period. Outflow was observed from the underdrain for all precipitation events (Table 9).

**Table 9. Runoff from underdrain in response to precipitation events at the RoadSafe site**

| Precipitation Event Start Date | Precipitation Event Metrics |                |                            |                             | Runoff from Underdrain (Present/Absent) |
|--------------------------------|-----------------------------|----------------|----------------------------|-----------------------------|---|
|                                | Depth (in)                  | Duration (hrs) | 5-Minute Intensity (in/hr) | 60-Minute Intensity (in/hr) |   |
| 8/2/2023                       | 0.10                        | 6.2            | 0.2                        | 0.1                         | Present                                 |
| 9/20/2023                      | 0.11                        | 2.7            | 0.3                        | 0.1                         | Present                                 |
| 10/11/2023                     | 0.13                        | 7.1            | 0.5                        | 0.1                         | Present                                 |
| 5/26/2023                      | 0.13                        | 1.3            | 0.7                        | 0.1                         | Present                                 |
| 6/2/2023                       | 0.15                        | 1.9            | 0.3                        | 0.1                         | Present                                 |
| 9/3/2023                       | 0.16                        | 6.3            | 0.5                        | 0.1                         | Present                                 |
| 6/12/2023                      | 0.19                        | 2.4            | 0.3                        | 0.1                         | Present                                 |
| 6/11/2023                      | 0.23                        | 7.8            | 0.3                        | 0.1                         | Present                                 |
| 8/6/2023                       | 0.26                        | 5.7            | 0.8                        | 0.2                         | Present                                 |
| 8/1/2023                       | 0.27                        | 2.3            | 1.1                        | 0.3                         | Present                                 |
| 8/27/2023                      | 0.31                        | 6.7            | 0.9                        | 0.3                         | Present                                 |
| 9/14/2023                      | 0.31                        | 16.9           | 0.5                        | 0.2                         | Present                                 |
| 8/8/2023                       | 0.32                        | 0.5            | 1.6                        | 0.3                         | Present                                 |
| 6/15/2023                      | 0.35                        | 3.7            | 0.3                        | 0.1                         | Present                                 |
| 9/10/2023                      | 0.39                        | 12.2           | 0.3                        | 0.2                         | Present                                 |
| 7/7/2023                       | 0.42                        | 6.2            | 1.9                        | 0.3                         | Present                                 |
| 6/5/2023                       | 0.55                        | 7.3            | 1.6                        | 0.5                         | Present                                 |
| 7/31/2023                      | 0.56                        | 8.4            | 0.5                        | 0.2                         | Present                                 |
| 6/6/2023                       | 0.59                        | 2.3            | 1.5                        | 0.6                         | Present                                 |
| 6/3/2023                       | 0.61                        | 17.9           | 0.3                        | 0.2                         | Present                                 |
| 6/16/2023                      | 0.61                        | 12.2           | 0.4                        | 0.2                         | Present                                 |
| 6/30/2023                      | 0.64                        | 2.0            | 1.8                        | 0.5                         | Present                                 |
| 7/20/2023                      | 0.74                        | 16.0           | 1.4                        | 0.3                         | Present                                 |
| 6/21/2023                      | 0.93                        | 8.8            | 0.9                        | 0.4                         | Present                                 |
| 7/4/2023                       | 1.06                        | 11.6           | 3.9                        | 0.6                         | Present                                 |
| 6/8/2023                       | 1.26                        | 4.6            | 2.5                        | 1.2                         | Present                                 |
| 6/22/2023                      | 1.75                        | 4.3            | 3.9                        | 1.7                         | Present                                 |

The results were unexpected for several reasons. First, as with the SEMSWA site, very little (if any) runoff would be expected from relatively small events and that runoff would likely only fill the soil voids. There were no indications that the grass swale was regularly irrigated, so saturated



## Runoff Reduction Field Monitoring in Cherry Creek Basin

soils was not a reasonable explanation. Second, results of the SRTs produced very little (if any) discharge through the underdrain.

The most plausible explanation for these results relates to the inlet pipe and soil riprap at the upstream end of the grass swale. The inlet pipe discharges runoff from a large parking lot into the swale, with large (Type L) soil riprap for energy dissipation. The construction drawings show the grass swale underdrain extends upstream of the inlet pipe and the soil riprap is installed to a depth of 1.3 feet (Figure 16). Although the underdrain is not visible from the surface, it is likely very close to the bottom of the riprap and creating a “short-circuit” condition where some of the pipe inflow flows directly into the underdrain.

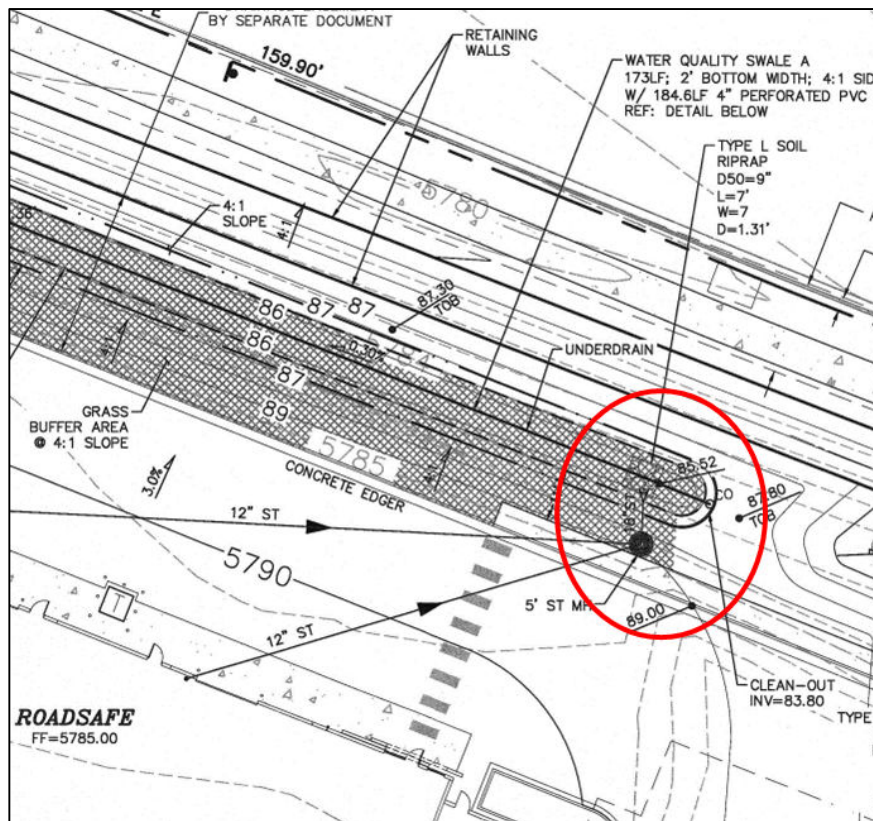

Figure 16. Screenshot from RoadSafe construction drawings showing inlet pipe, riprap and underdrain locations (circled in red)

### 5.3.4 Soil Analysis

Two 6-inch-depth soil cores (0 – 6” depth and 6 – 12” depth) were collected on November 1, 2023, and sent to the Colorado State University SPUR Soil, Water and Plant Testing Laboratory for full chemical and physical analysis. Soil texture analysis of both samples indicated the media at the RoadSafe site consists of sandy loam soil (Figure 17). This is consistent with the construction drawings and MHPD bioretention media criteria (which the construction drawings reference). The full soils report is included in Appendix 2.

## Runoff Reduction Field Monitoring in Cherry Creek Basin

During soil sample collection, field staff observed two anomalies. First, near the bottom of the 6 – 12” soil core, there was an obvious clay layer about 1 – 2” thick. This was not expected as the construction drawings called for “growing media” and “filter media” to a minimum depth of 12”. The soil core was taken directly above the underdrain, therefore it is possible that the underdrain was backfilled with native soils instead of “drainage media.”

Second, there appeared to be a thin (< 1”) crust of sediment accumulated at the surface of the swale. This is a clear indication of sediment buildup within the swale and likely is inhibiting infiltration into the underlying soils and underdrain.

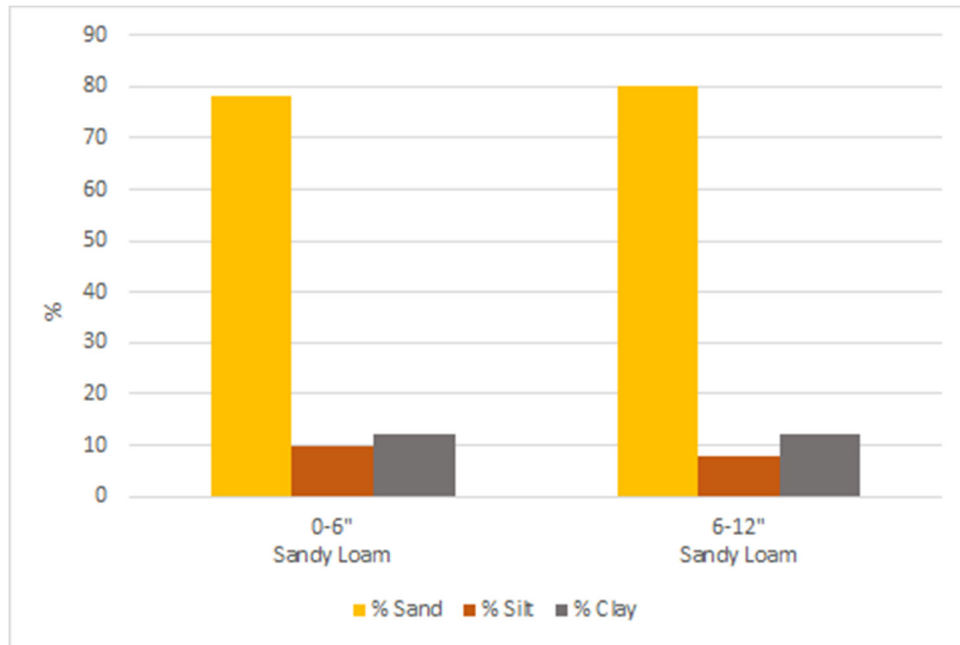

Figure 17. Soil texture analysis of RoadSafe site

### 5.4 Central Centennial

#### 5.4.1 Introduction

The Central Centennial industrial buildings, located at 7173 S. Revere Parkway in Centennial, have two grass swales (the south swale and the southeast swale) designed to meet the SEMSWA 20/10 rule for disconnected impervious area (Figure 18). Both grass swales receive runoff from adjacent impervious areas through distributed curb cuts and are both underdrained. The underdrains from each swale combine upstream of the outlet structure. Vegetation is well-maintained, highly-irrigated turfgrass.

According to the drainage report (WBC Engineering & CM, 2019), 25,600 sf of UIA drains to the 2,600 sf south RPA, and 7,600 sf of UIA drains to the 850 sf southeast RPA. The combined UIA:RPA ratio for both swales is 10:1, and the UIA:RPA for the southeast swale only is 9:1. Design characteristics of both grass swales are included in Table 10. As-builts are dated 2021.



Figure 18. Central Centennial industrial building with two swales draining to single outlet structure (Google Earth image)

Table 10. Design characteristics of Central Centennial grass swales

| Central Centennial SCM Characteristics        |  |  |
|---|--|--|
|   | South Swale  | Southeast Swale  |
| Infiltration Material (upper to lower layers) | 12" sandy loam growing media<br>3" Class C<br>3" Class B<br>9" Class A around underdrain | 12" sandy loam growing media<br>3" Class C<br>3" Class B<br>9" Class A around underdrain |
| Underdrain                                    | Perforated   | Perforated   |
| Underdrain Diameter (in)                      | 4  | 4  |
| Approximate Length (ft)                       | 557  | 189  |
| Approximate Width (ft)                        | 4.6  | 4.5  |
| Side Slopes (H:V)                             | 4  | 4  |
| Design Slope                                  | 0.005  | 0.010  |
| UIA:RPA                                       | 10:1   | 9:1  |

#### 5.4.2 Summary of SRTs

Four SRTs were completed at the Central Centennial southeast bioswale from September through October 2023 (Table 11). The southeast swale was chosen for SRT because of its smaller size and proximity to a fire hydrant. Field observations at the first SRT indicated the site could accept volumes exceeding the WQCV, therefore a range of inflow volumes was used from 2,000 – 6,800

---

## Runoff Reduction Field Monitoring in Cherry Creek Basin

---

gallons. The WQCV for the contributing area to the southeast bioswale is approximately 2,000 gallons. The duration of testing varied from 15 – 25 minutes.

**Table 11. Summary of SRTs performed at Central Centennial southeast grass swale**

| Date               | Inflow Rate (gpm) | Inflow Volume (gal) | Duration of Inflow (min) |
|--------------------|-------------------|---------------------|--------------------------|
| September 6, 2023  | 155               | 4,000               | 25                       |
| September 18, 2023 | 270               | 6,800               | 25                       |
| September 26, 2023 | 215               | 5,400               | 25                       |
| October 5, 2023    | 135               | 2,000               | 15                       |

The Central Centennial site performed as expected. No observations were made of unexpected or site-specific characteristics that may have affected the results of the SRT.

### **5.4.3 SRTs – Results and Discussion**

The total inflow volume for the four SRTs ranged from 2,000 – 6,800 gallons, and the total outflow ranged from approximately 700 – 3,700 gallons (Figure 19). The runoff volume reduction observed for the four SRTs ranged from approximately 50 – 70% (Figure 19 and Figure 20). The lowest volume reduction of 47% occurred during the second SRT, with the greatest inflow volume (6,800 gallons) applied at the highest inflow rate (270 gpm). The greatest volume reduction (71%) was observed during the third SRT, with an inflow volume of 5,400 gallons at a rate of 215 gpm. The inflow volume of the fourth SRT was similar to the WQCV at 2,000 gallons and had a 66% volume reduction.

There is a time lag of nearly 20 minutes between the time that inflows started and the time that outflows started in the underdrain. This demonstrates the swale effectively increases the time of concentration for the site.



## Runoff Reduction Field Monitoring in Cherry Creek Basin

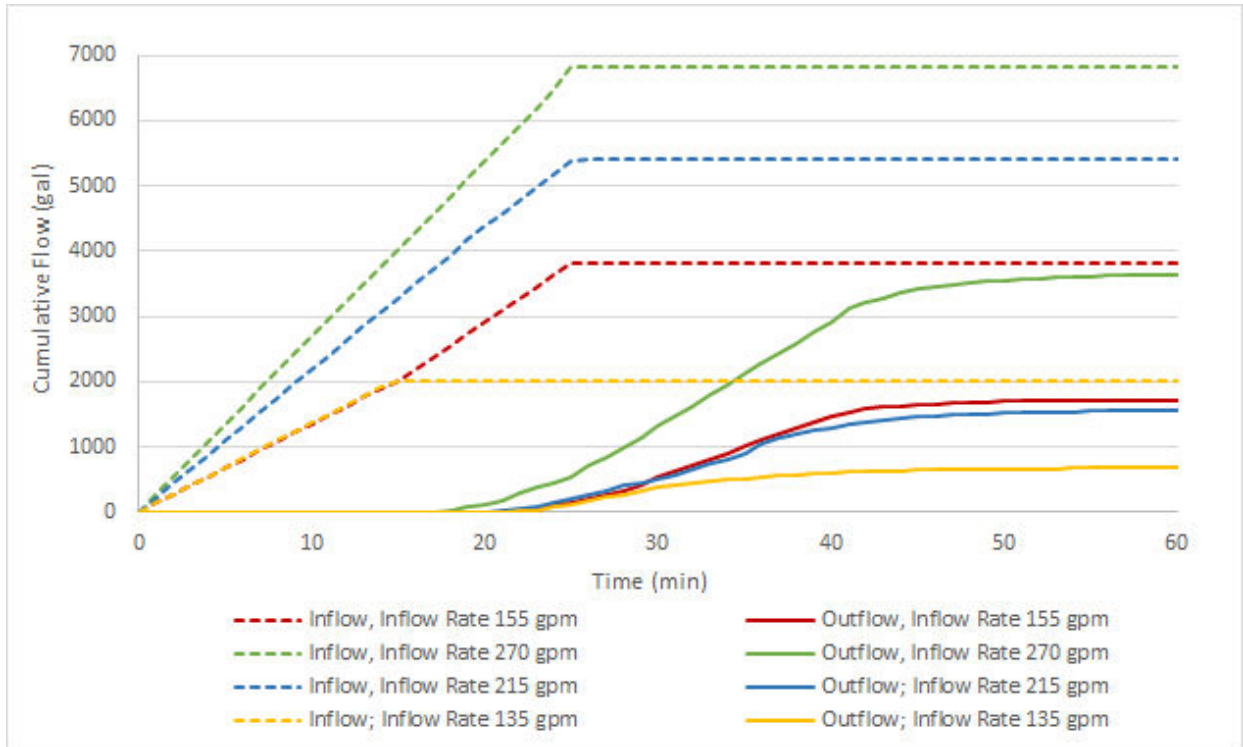

**Figure 19. Cumulative inflow and outflow during SRTs at Central Centennial site**

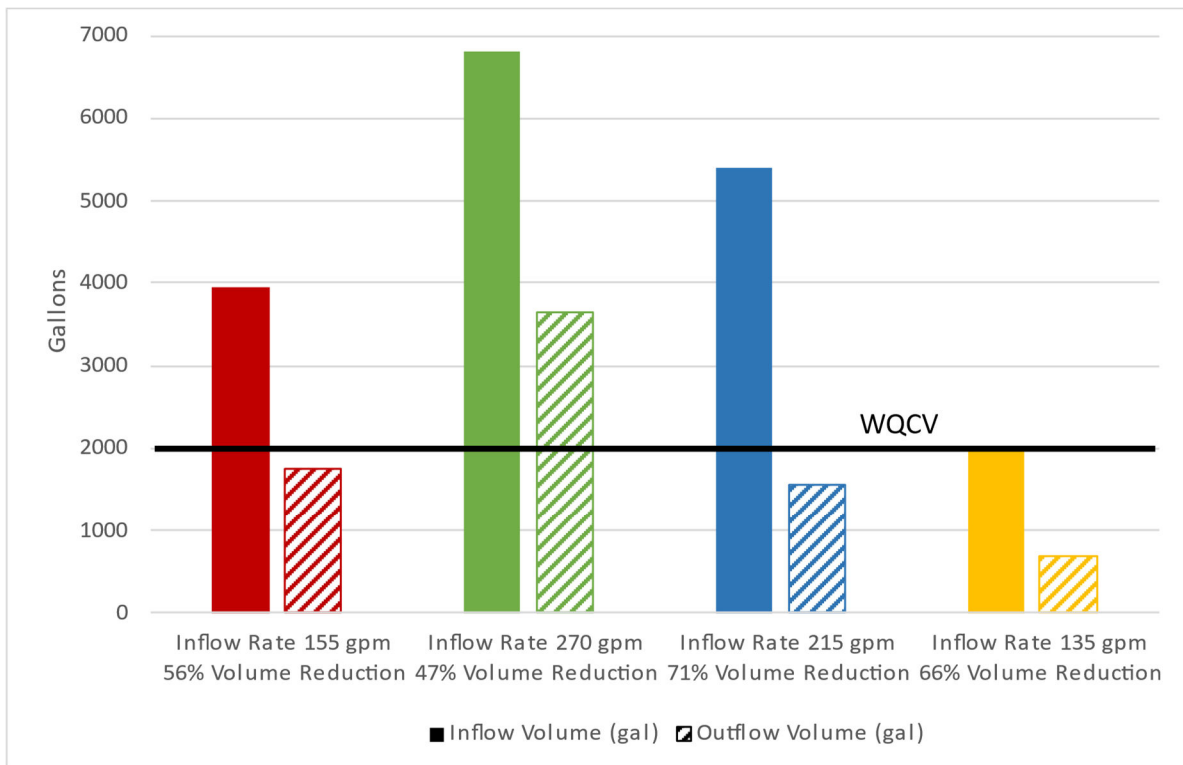

**Figure 20. Volume reduction observed at Central Centennial SRTs**

## Runoff Reduction Field Monitoring in Cherry Creek Basin

The maximum inflow rate varied between 135 – 270 gpm for each of the SRTs, and the peak outflow rate varied between 60 – 225 gpm (Figure 21). The reduction in peak flow rate ranged from 15 – 55% (Table 12 and Figure 22).

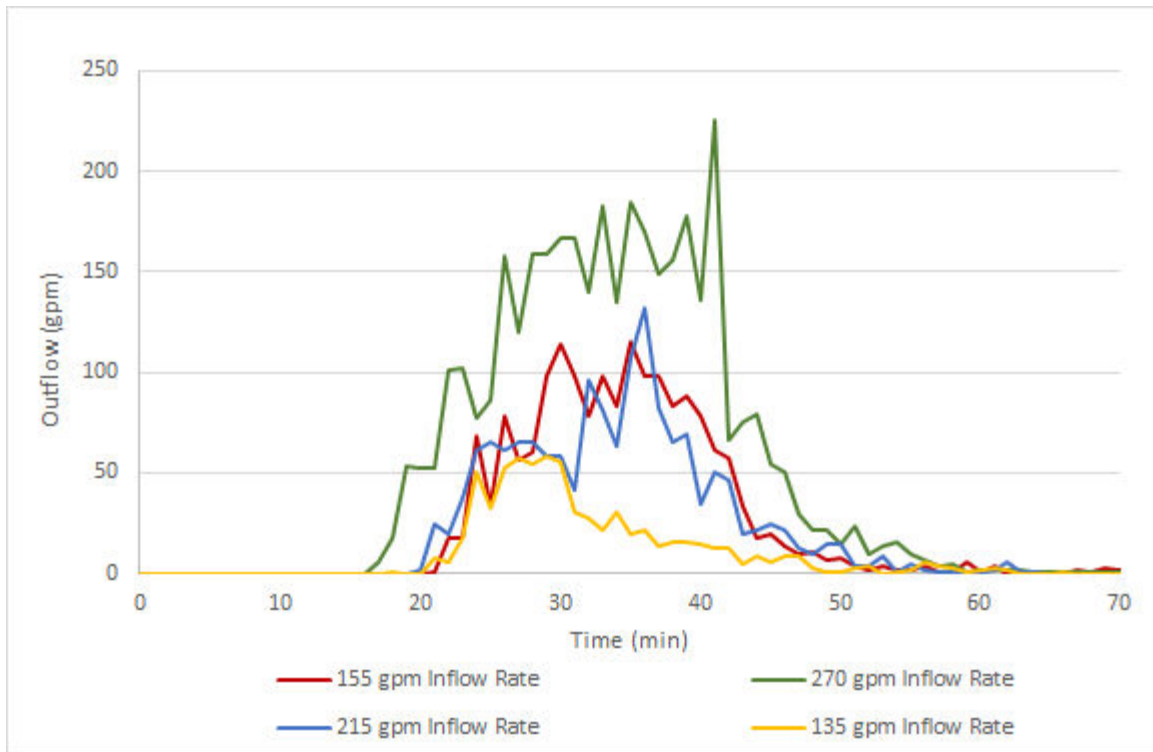

**Figure 21. Instantaneous weir flow during SRTs at Central Centennial Site**

## Runoff Reduction Field Monitoring in Cherry Creek Basin

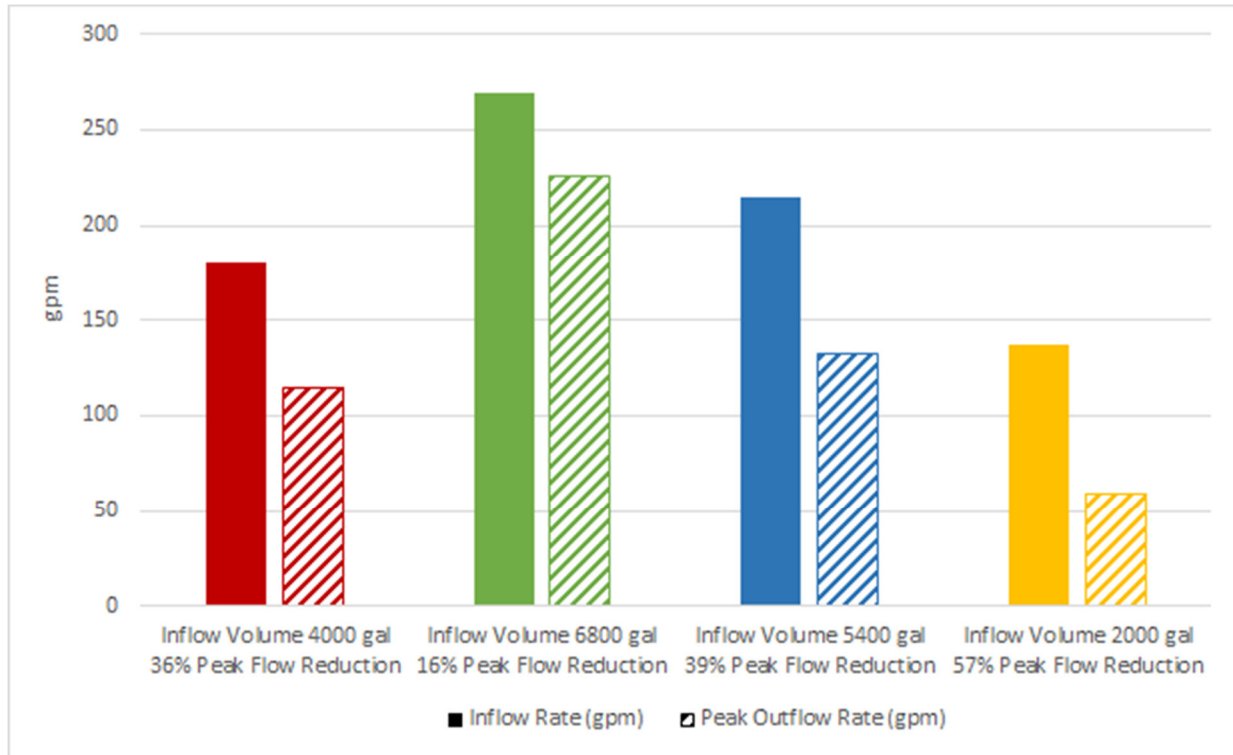
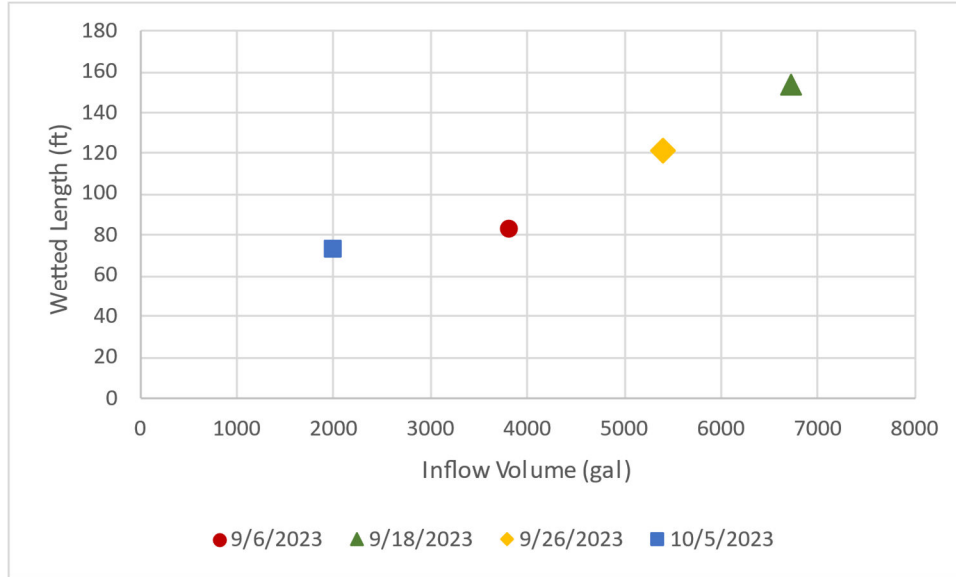

**Figure 22. Peak flow reduction observed at Central Centennial SRTs**

The maximum wetted length varied between approximately 70 – 150 feet (Figure 23 and Figure 24) for each SRT. The shortest wetted length (72 feet) occurred during the SRT using the lowest inflow rate (135 gpm) and volume (2,000 gallons). The longest wetted length (154 feet) occurred during the SRT with the highest inflow rate (270 gpm) and volume (6,800 gallons).

The results indicate a relationship between both inflow volume and rate and wetted length. A possible explanation for the stronger relationship observed between inflow volume and wetted length at Central Centennial than was observed at the SEMSWA site is the difference in vegetation characteristics. The SEMSWA bioswale is landscaped with tall grasses that would produce higher surface roughness than the highly manicured turfgrass at Central Centennial. Higher inflow rates would be needed to promote surface flow at SEMSWA. Results at both sites are consistent with expectations and theory, with larger inflow rates and volumes resulting in greater wetted swale lengths.

## Runoff Reduction Field Monitoring in Cherry Creek Basin



**Figure 23. Wetted length and inflow volume during SRTs at Central Centennial site**

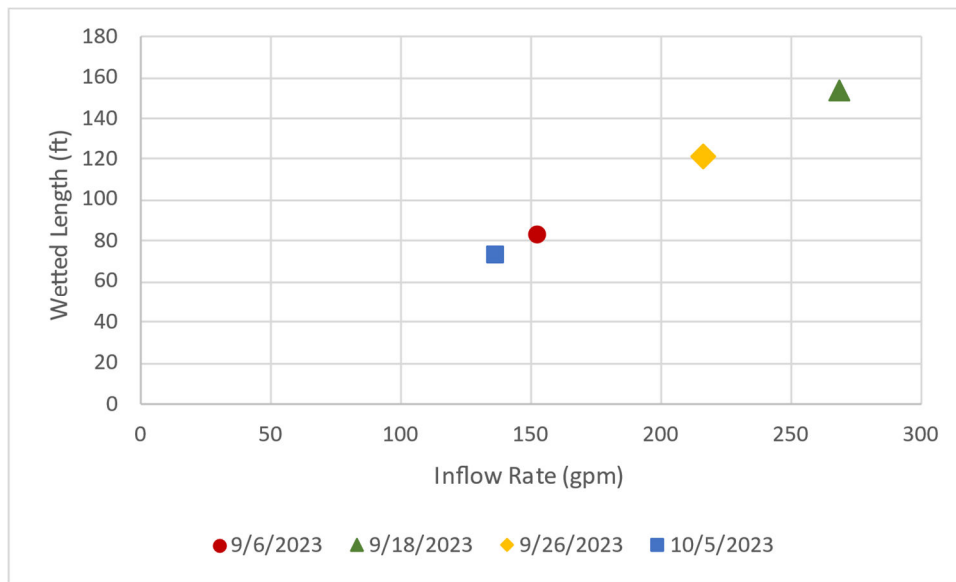

**Figure 24. Wetted length and inflow rate during SRTs at Central Centennial site**

Table 12 summarizes the SRT results. As noted above, the inflow volumes were generally equal to or much greater than the WQCV (2,000 gallons) for the contributing area. The results demonstrate that the grass swale provides considerable runoff volume reduction and would meet the Runoff Reduction Standard under certain flow conditions.

**Runoff Reduction Field Monitoring in Cherry Creek Basin**

---

**Table 12. Runoff volume and peak flow reduction measured during SRTs at Central Centennial**

| <b>Date</b> | <b>Application Rate (gpm)</b> | <b>Maximum Outflow Rate (gpm)</b> | <b>Inflow Volume (gal)</b> | <b>Outflow Volume (gal)</b> | <b>Runoff Volume Reduction (%)</b> | <b>Peak Flow Reduction (%)</b> |
|-------------|-------------------------------|-----------------------------------|----------------------------|-----------------------------|------------------------------------|--------------------------------|
| 9/6/2023    | 155                           | 115                               | 4,000                      | 1,760                       | 56                                 | 36                             |
| 9/18/2023   | 270                           | 225                               | 6,800                      | 3,650                       | 47                                 | 16                             |
| 9/26/2023   | 215                           | 130                               | 5,400                      | 1,560                       | 71                                 | 39                             |
| 10/5/2023   | 135                           | 60                                | 2,000                      | 690                         | 66                                 | 57                             |

**5.4.4 Ambient Monitoring – Results and Discussion**

Twenty-eight precipitation events of at least 0.1-inch depth occurred at the Central Centennial site during the monitoring period. Outflow was observed from the underdrain for most events with total precipitation depth exceeding 0.15 inches, but most events below that threshold did not result in underdrain discharge (Table 13). As noted above, ambient monitoring of the underdrain included runoff and underdrain discharge from both the south and southeast swale.

These results, with a few exceptions, demonstrate that a total precipitation depth of 0.15 inches is a threshold that defines the presence or absence of underdrain discharge. This means that runoff from most events with less than 0.15 inches of precipitation is retained and infiltrated within the grass swales.

## Runoff Reduction Field Monitoring in Cherry Creek Basin

**Table 13. Runoff from underdrain in response to precipitation events at Central Centennial site**

| Precipitation Event Start Date | Precipitation Event Metrics |                |                            |                             | Underdrain Flow Present/Absent |
|--------------------------------|-----------------------------|----------------|----------------------------|-----------------------------|--------------------------------|
|                                | Depth (in)                  | Duration (hrs) | 5-Minute Intensity (in/hr) | 60-Minute Intensity (in/hr) |                                |
| 5/25/2023                      | 0.10                        | 2.8            | 0.3                        | 0.1                         | Absent                         |
| 9/3/2023                       | 0.12                        | 6.6            | 0.2                        | 0.1                         | Absent                         |
| 7/7/2023                       | 0.13                        | 6.3            | 0.5                        | 0.1                         | Absent                         |
| 8/6/2023                       | 0.14                        | 6.7            | 0.3                        | 0.1                         | Present                        |
| 5/26/2023                      | 0.15                        | 1.4            | 0.9                        | 0.1                         | Absent                         |
| 10/11/2023                     | 0.15                        | 6.7            | 0.2                        | 0.1                         | Absent                         |
| 8/25/2023                      | 0.15                        | 2.5            | 0.3                        | 0.1                         | Present                        |
| 5/31/2023                      | 0.16                        | 1.6            | 0.9                        | 0.1                         | Absent                         |
| 6/5/2023                       | 0.17                        | 4.1            | 0.4                        | 0.1                         | Present                        |
| 6/12/2023                      | 0.17                        | 2.4            | 0.4                        | 0.1                         | Present                        |
| 8/27/2023                      | 0.19                        | 6.6            | 0.6                        | 0.2                         | Present                        |
| 8/1/2023                       | 0.22                        | 2.5            | 0.9                        | 0.2                         | Present                        |
| 9/14/2023                      | 0.26                        | 6.6            | 0.5                        | 0.2                         | Present                        |
| 6/1/2023                       | 0.28                        | 1.7            | 0.9                        | 0.3                         | Present                        |
| 6/2/2023                       | 0.28                        | 2.1            | 0.3                        | 0.2                         | Present                        |
| 6/11/2023                      | 0.31                        | 8.0            | 0.4                        | 0.1                         | Absent                         |
| 7/4/2023                       | 0.32                        | 5.3            | 1.0                        | 0.2                         | Present                        |
| 6/15/2023                      | 0.38                        | 3.7            | 0.4                        | 0.2                         | Present                        |
| 9/10/2023                      | 0.45                        | 16.3           | 0.3                        | 0.2                         | Present                        |
| 8/2/2023                       | 0.45                        | 6.4            | 1.4                        | 0.4                         | Present                        |
| 6/4/2023                       | 0.47                        | 9.8            | 0.3                        | 0.2                         | Present                        |
| 6/21/2023                      | 0.48                        | 4.3            | 0.6                        | 0.3                         | Present                        |
| 6/16/2023                      | 0.56                        | 8.4            | 0.7                        | 0.2                         | Present                        |
| 7/20/2023                      | 0.79                        | 15.9           | 0.9                        | 0.2                         | Present                        |
| 7/31/2023                      | 0.86                        | 13.0           | 1.3                        | 0.5                         | Present                        |
| 6/29/2023                      | 1.35                        | 9.6            | 3.9                        | 1.2                         | Present                        |
| 6/8/2023                       | 1.39                        | 4.7            | 2.1                        | 1.3                         | Present                        |
| 6/22/2023                      | 1.80                        | 6.0            | 3.9                        | 1.8                         | Present                        |

### 5.4.5 Soil Analysis – Results and Discussion

Two 6-inch-depth soil cores (0 – 6” depth and 6 – 12” depth) were collected on November 1, 2023 and sent to the Colorado State University SPUR Soil, Water and Plant Testing Laboratory for full chemical and physical analysis. The soil texture for the 0 – 6” sample is sandy clay loam and the 6 – 12” sample is sandy loam (Figure 25). The full soils report is included in Appendix 2.

The soil gradations are consistent with the construction drawings, which reference the MHFD bioretention media specifications.

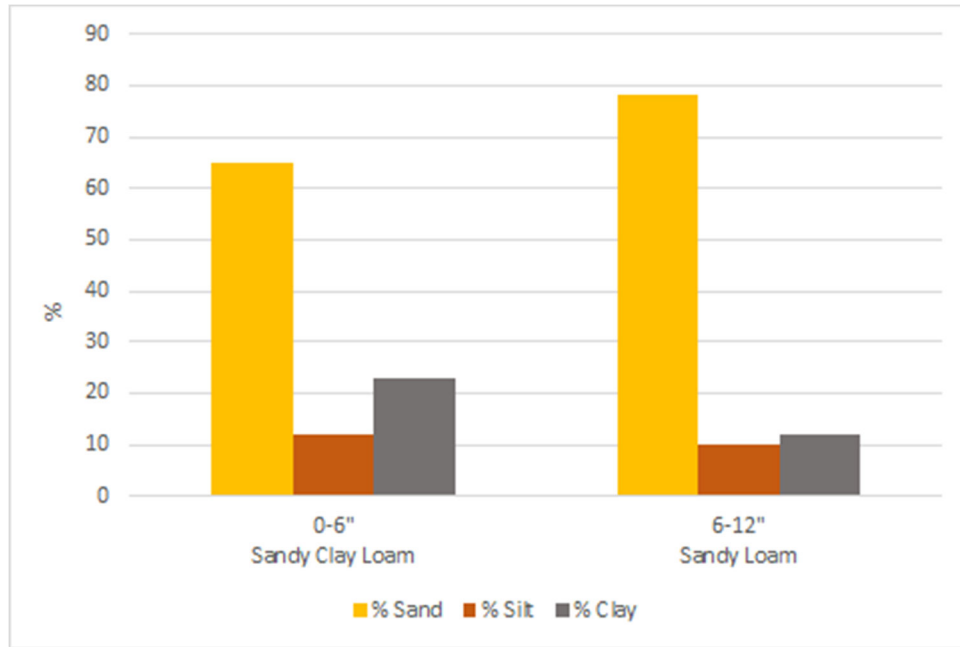

**Figure 25. Soil texture analysis of Central Centennial site**

## 5.5 Smith & Smith

### 5.5.1 Introduction

The Smith & Smith industrial building, located at 6281 S. Racine Circle in Centennial, has a grass swale designed to meet the SEMSWA 20/10 rule for disconnected impervious area (Figure 26). The grass swale receives runoff from the adjacent parking lot through slotted curb openings. The street side of the swale is dense Kentucky bluegrass that is well-maintained and well-irrigated. The parking lot side of the swale consists of rock and shrubs with a weed barrier underneath. The drainage report and construction drawings are dated 2018.

According to the drainage report (Civil Resources, 2017), the UIA draining to the swale is approximately 24,000 sf, and the treatment area is approximately 2,400 sf for a UIA:RPA ratio of 10:1. However, field observations suggest the functional portion of the swale is actually much smaller, at just over 300 feet long and 1 foot wide due to grading issues (Table 14); therefore, the actual UIA:RPA ratio for the swale is closer to 76:1. The WQCV for the contributing area is approximately 5,900 gallons.



## Runoff Reduction Field Monitoring in Cherry Creek Basin

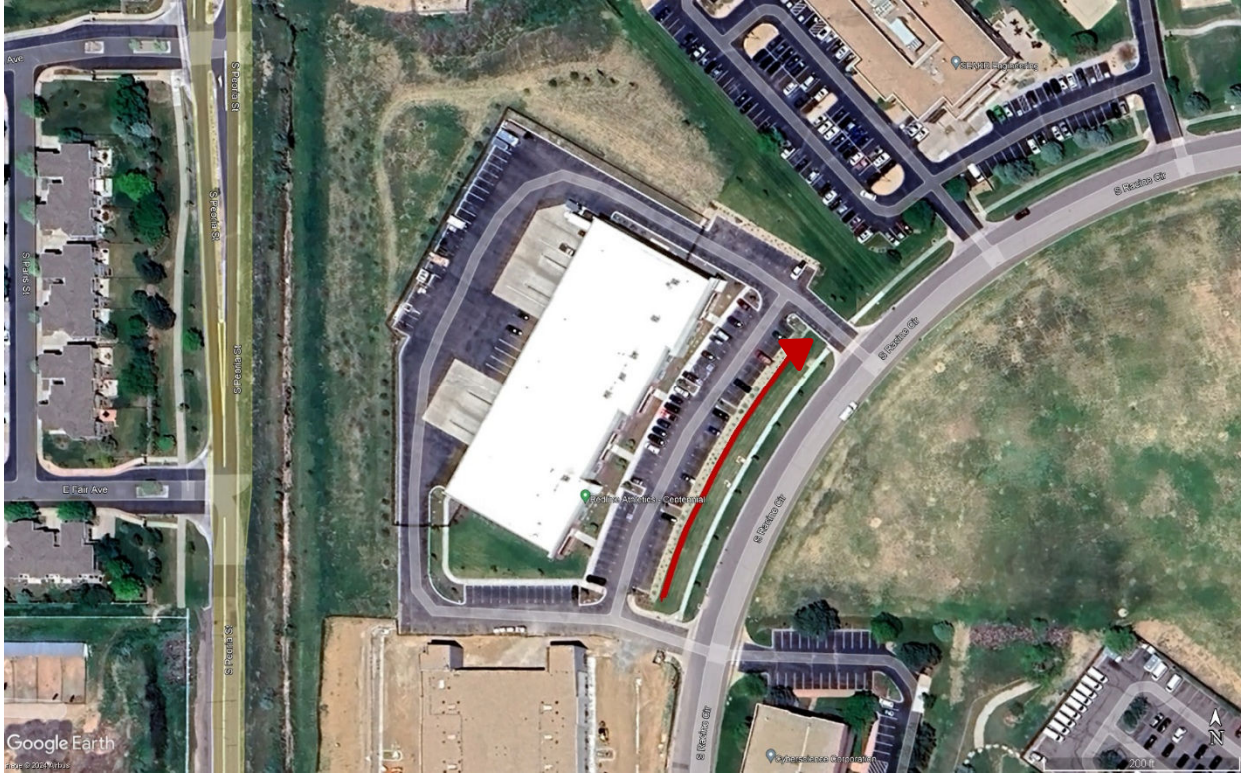

**Figure 26. Smith & Smith industrial building with grass/rock swale**

**Table 14. Characteristics of Smith & Smith grass/rock swale**

| Smith & Smith SCM Characteristics                |   |
|--|---|
| Infiltration Material<br>(upper to lower layers) | 6" growing media<br>6" filter media<br>9" drainage media around<br>underdrain |
| Underdrain                                       | Slotted   |
| Underdrain Diameter (in)                         | 6   |
| Approximate Length (ft)                          | 314   |
| Approximate Width (ft)                           | 1   |
| Side Slopes (H:V)                                | 5   |
| Design Slope                                     | 0.008   |
| Design UIA:RPA                                   | 10:1  |
| Field-Estimated UIA:RPA of Swale                 | 76:1  |

### 5.5.2 SRTs

Four SRTs were completed at the Smith & Smith site with inflow rates varying between 80 – 190 gpm and total inflow volumes ranging between 1,100 – 2,800 gallons (Table 15).



## Runoff Reduction Field Monitoring in Cherry Creek Basin

**Table 15. Summary of SRTs performed at Smith & Smith grass/rock swale**

| Date               | Inflow Rate (gpm) | Inflow Volume (gal) | Outflow Volume (gal)           | Duration of Inflow (min) |
|--------------------|-------------------|---------------------|--------------------------------|--------------------------|
| September 6, 2023  | 80                | 1,100               | Unable to measure <sup>1</sup> | 13                       |
| September 18, 2023 | 190               | 2,800               | Unable to measure <sup>1</sup> | 15                       |
| September 26, 2023 | 110               | 1,600               | 0                              | 15                       |
| October 5, 2023    | 190               | 1,700               | Minimal                        | 9                        |

<sup>1</sup>Flow overtopping the outlet box and coming from the underdrain.

### 5.5.2.1 SRT 1 – September 6, 2023

The first SRT was performed using an inflow rate of approximately 80 gpm. The distance from the fire hydrant to the swale was longer than expected which necessitated an inflow point approximately 60 feet upstream of the outlet box. Surface flow was observed in both directions from the inflow point, indicating areas of negative slope along the swale (Figure 27). Surface flow occurred more quickly than anticipated, and sandbags were installed where the slope increased toward the outlet box to impede flow. The water was turned off after 13 minutes and approximately 1,100 gallons. Inflow continued downstream and ultimately overtopped the outlet box (Figure 28).



**Figure 27. Upstream flow (to the left of the fire hose in the photo) observed during the first SRT at Smith & Smith site**



**Figure 28. Flow overtopping the outlet box and outflows from the underdrain observed during the first SRT at Smith & Smith**

The results of this SRT were clearly not as expected and did not produce quantitative runoff reduction results. However, additional SRTs were conducted with various modifications, as discussed below.

### **5.5.2.2 SRT 2 – September 18, 2023**

For this SRT, inflows were discharged near the upstream end of the swale<sup>11</sup> at a rate of approximately 190 gpm. The inflow was turned off when surface flows reached about 150 feet (50% of the swale length) and the total inflow volume was approximately 2,800 gallons. Surface flow continued down the swale after the inflow was shut off, and sandbags were placed at 240 and 260 feet to slow surface flow. Approximately 45 minutes after the start of the test, surface flows overtopped into the outlet structure. Some flow was also observed from the underdrain, although the majority of outflow occurred as surface flow overtopping into the outlet structure.

The invert of the swale appeared to coincide closely with the boundary between the grass and rock, with a significant portion of flow occurring in the rocks (Figure 29). Landscaping fabric was observed beneath the rock layer. Infiltration along the length of the swale appeared to be minimal, with surface flow progressing at a rapid rate.

---

<sup>11</sup> A longer fire hose was procured to allow for using a different fire hydrant from the first SRT.



**Figure 29. Flow observed in rocks during SRTs at Smith & Smith site<sup>12</sup>**

### **5.5.2.3 SRT 3 – September 26, 2023**

This SRT was conducted with a lower inflow rate (110 gpm) than the second SRT and lower inflow volume (1,600 gallons) to prevent surface flow from overtopping into the outlet structure. The inflow was turned off when surface flows reached approximately 100 feet (33% of the entire swale length) from the inflow location and surface flows did not overtop into the outlet structure. No outflows from the underdrain were observed.

### **5.5.2.4 SRT 4 – October 5, 2023**

This SRT was conducted at an inflow rate of 190 gpm and the total inflow volume was 1,700 gallons. The inflow was turned off when surface flows reached approximately 100 feet (33% of the entire swale length) from the inflow location. The last recorded wetted length was 221 feet, 45 minutes after the start of the test. However, a minimal amount of surface flow overtopping the

---

<sup>12</sup> Photo shows that the runoff is not contained in the grass swale and would be infiltrating in a landscaped area (does not meet design criteria for type of surface cover).

outlet structure and in the underdrain is observed in photos at 1 hour 19 minutes after the start of the test.

### **5.5.2.5 SRT - Summary Results and Discussion**

As noted during the first SRT, the swale had an inconsistent slope and low infiltration capacity as evidenced by inflow moving both upstream and downstream from the inflow point. We applied an inflow volume of approximately 1,100 gallons, roughly 20% of the WQCV for the site. Despite the addition of sandbags and turning off the water, flow continued both upstream and downstream, ultimately overtopping the outlet box.

Results of the second SRT confirmed the very low infiltration capacity of the swale and showed that a significant portion of flow occurs in the neighboring rock garden, which is lined with landscaping fabric. Roughly 300 feet of swale was unable to infiltrate the 2,800-gallon inflow without overtopping into the outlet structure.

The third and fourth SRTs were conducted to determine the minimum volume of inflow that could be contained and infiltrated within the swale. The results of these tests showed that approximately 1,600 gallons could be captured and retained, which is approximately 27% of the WQCV for the contributing area.

### **5.5.3 Ambient Monitoring – Results and Discussion**

Twenty-three precipitation events of at least 0.1-inch depth occurred at the Smith & Smith site during the monitoring period. Outflow was observed from the underdrain for most precipitation events (Table 16) the majority of which also showed surface flow into the outlet box from above. Three events showing no outflow had total rainfall depths of 0.16, 0.18, and 0.24 inches. Outflow was observed for several rainfall events of similar and smaller depths (0.13 inches), therefore a depth threshold for runoff cannot be discerned from these results.

The ambient results were not surprising for several reasons. First, although the drainage report indicates a UIA:RPA ratio for the subbasin of 4:1, field observations suggest a dramatically different UIA:RPA ratio closer to 76:1 for the swale. Even small amounts of runoff quickly overwhelmed the undersized swale. Second, soil analysis (discussed in the following section) indicates a high clay content that would decrease infiltration rates in the swale. This hypothesis is supported by the majority of runoff-producing events overflowing into the outlet box from above.



## Runoff Reduction Field Monitoring in Cherry Creek Basin

**Table 16. Runoff from underdrain in response to precipitation events at Smith & Smith site**

| Precipitation Event Start Date | Precipitation Event Metrics |                |                            |                             | Underdrain Flow Present/Absent |
|--------------------------------|-----------------------------|----------------|----------------------------|-----------------------------|--------------------------------|
|                                | Depth (in)                  | Duration (hrs) | 5-Minute Intensity (in/hr) | 60-Minute Intensity (in/hr) |                                |
| 6/1/2023                       | 0.13                        | 1.8            | 0.42                       | 0.12                        | Present                        |
| 5/25/2023                      | 0.16                        | 2.8            | 0.28                       | 0.10                        | Absent                         |
| 7/5/2023                       | 0.16                        | 5.6            | 0.52                       | 0.09                        | Present                        |
| 8/25/2023                      | 0.17                        | 1.9            | 0.35                       | 0.14                        | Present                        |
| 8/1/2023                       | 0.17                        | 2.4            | 0.54                       | 0.16                        | Present                        |
| 5/31/2023                      | 0.18                        | 1.7            | 1.06                       | 0.18                        | Absent                         |
| 6/5/2023                       | 0.20                        | 7.0            | 0.65                       | 0.15                        | Present                        |
| 9/14/2023                      | 0.24                        | 6.5            | 0.35                       | 0.18                        | Present                        |
| 8/27/2023                      | 0.24                        | 6.8            | 0.95                       | 0.17                        | Absent                         |
| 7/4/2023                       | 0.32                        | 5.4            | 1.08                       | 0.18                        | Present                        |
| 6/2/2023                       | 0.34                        | 2.1            | 0.64                       | 0.25                        | Present                        |
| 6/11/2023                      | 0.39                        | 8.1            | 0.73                       | 0.22                        | Present                        |
| 9/10/2023                      | 0.42                        | 16.3           | 0.40                       | 0.20                        | Present                        |
| 8/2/2023                       | 0.45                        | 7.6            | 0.92                       | 0.39                        | Present                        |
| 6/3/2023                       | 0.50                        | 18.1           | 0.42                       | 0.21                        | Present                        |
| 6/15/2023                      | 0.50                        | 3.1            | 0.48                       | 0.27                        | Present                        |
| 6/16/2023                      | 0.53                        | 12.5           | 0.67                       | 0.16                        | Present                        |
| 6/21/2023                      | 0.57                        | 4.5            | 0.88                       | 0.37                        | Present                        |
| 7/20/2023                      | 0.61                        | 15.8           | 0.56                       | 0.22                        | Present                        |
| 7/31/2023                      | 0.70                        | 8.7            | 0.80                       | 0.35                        | Present                        |
| 6/29/2023                      | 0.89                        | 9.0            | 1.36                       | 0.76                        | Present                        |
| 6/22/2023                      | 1.36                        | 6.1            | 2.56                       | 1.22                        | Present                        |
| 6/8/2023                       | 1.75                        | 4.8            | 2.14                       | 1.62                        | Present                        |

### 5.5.4 Soil Analysis – Results and Discussion

Two 6-inch-depth soil cores (0 – 6” depth and 6 – 12” depth) were collected on November 1, 2023 and sent to the Colorado State University SPUR Soil, Water and Plant Testing Laboratory for full chemical and physical analysis. Soil texture analysis for the 0 – 6” sample indicated a sandy clay loam and the 6 – 12” sample indicated a clay loam. The full soils report, including chemical analysis, is included in Appendix 2.

The soil analysis results are not consistent with construction drawings, which reference the MHFD bioretention “growing media” and “filter media.” Specifically, the clay content of the soil samples was considerably higher than specifications (i.e., 30% greater than the specified clay content). The soil analysis was also consistent with field staff observations. Collecting soil samples at this site was very difficult due to the high clay content.

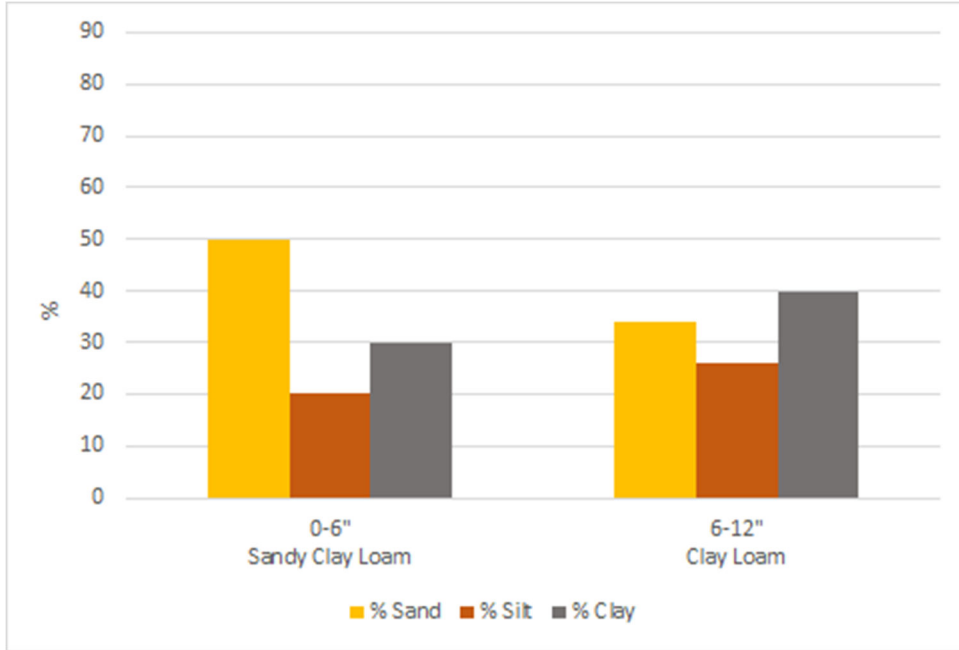

Figure 30. Soil texture analysis of Smith & Smith site

## 6.0 INFILTRATION BASINS

### 6.1 Introduction

Infiltration basins are a type of RPA that simply capture and retain runoff until it infiltrates, evaporates, or evapotranspires. The most basic type of infiltration basin does not require overly sophisticated engineering design, provided the underlying soils provide adequate infiltration capacity for the design event. Neither MHFD nor SEMSWA provide design criteria for infiltration basins.

Three infiltration basins were monitored for this project. Two of the infiltration basins are located within Cherry Creek State Park (CCSP), and one is located at the 17 Mile House Farm Park (17 Mile House) in unincorporated Arapahoe County (Figure 31).

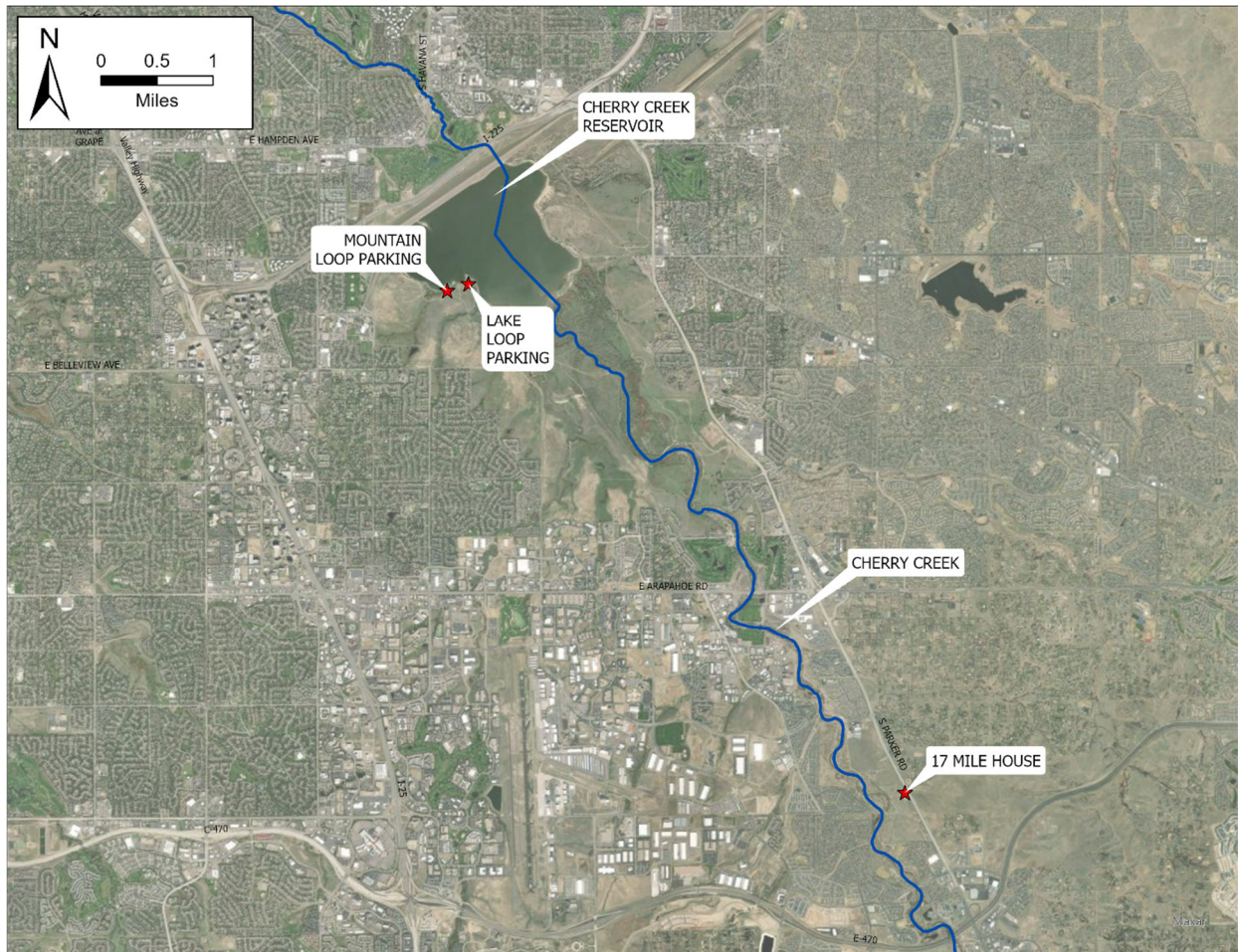

Figure 31. Study infiltration basins



## 6.2 CCSP Lake Loop Infiltration Basin

### 6.2.1 Introduction

The Lake Loop parking area in CCSP is a paved parking lot of approximately 0.6 acres. An estimated 0.25 acres of the parking lot drains to the infiltration basin (Figure 32). The infiltration basin has a surface area of approximately 1,230 sf.<sup>13</sup> The UIA:RPA is approximately 9:1 for the infiltration basin. Construction drawings indicate the infiltration basin was amended with 18” of sandy loam material and only required some minor regrading work. No other infrastructure (e.g., inlet/outlet structures, underdrains) was installed. The basin is well-vegetated with tall grasses and is not irrigated. This basin is considered minimally engineered.

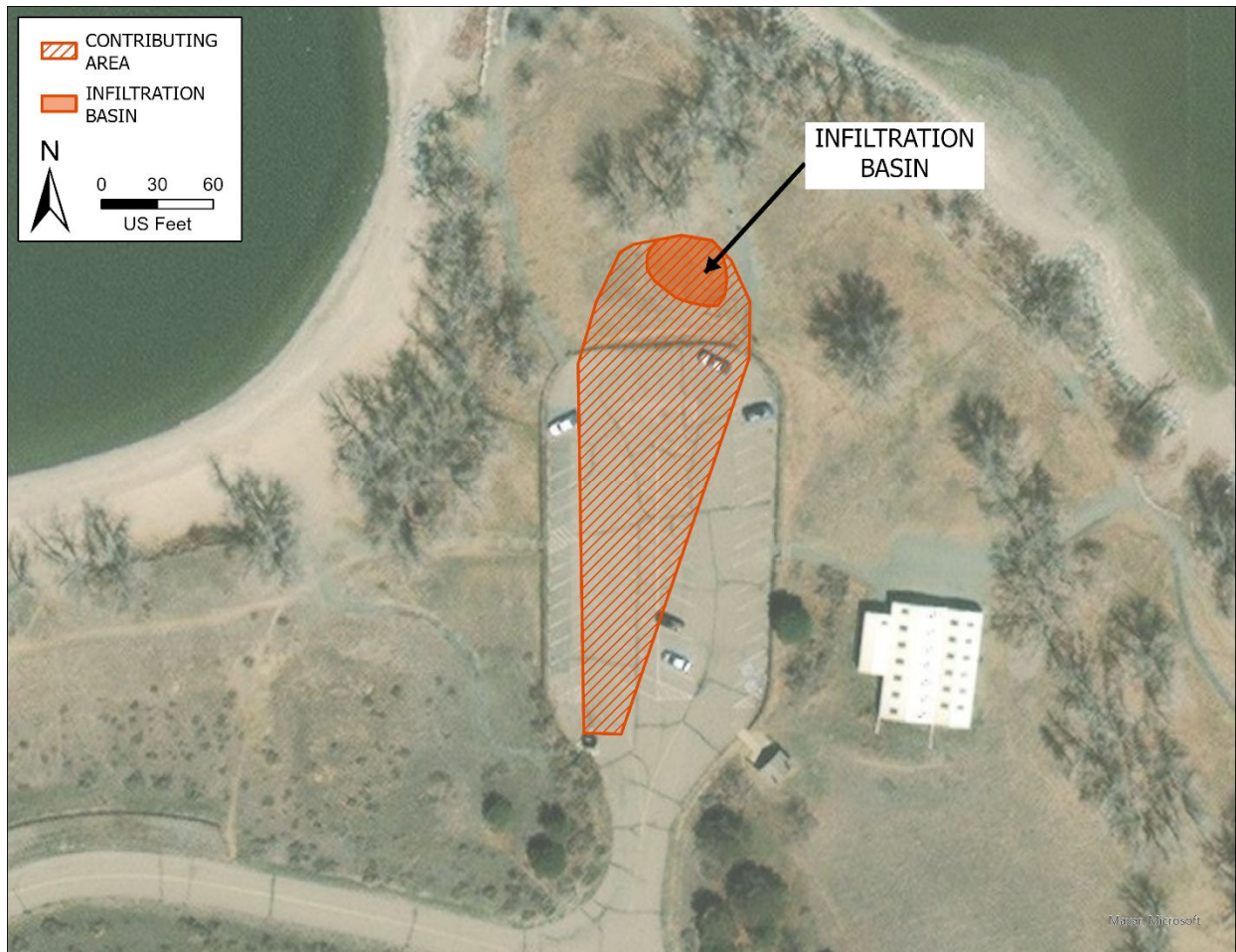

**Figure 32. Approximate Lake Loop parking and grassy area draining to infiltration basin**

<sup>13</sup> As-built drawing from Muller, 2013.

### 6.2.2 Ambient Monitoring – Methods

The infiltration basin was monitored using a trail camera programmed to take a photograph every 5 minutes, 24 hours per day. The camera was installed on June 28, 2023, and removed November 1, 2023 (Figure 33).

The photographs were used to determine the presence or absence of ponded water in the infiltration basin during precipitation events. In addition, a staff gauge was installed in the center of the infiltration basin to record ponded water depths. Infiltration rates were estimated based on staff gauge readings during precipitation events. Precipitation event data were collected and analyzed as described in previous sections of this report.



**Figure 33. Installation of camera and staff gauge in Lake Loop basin**

### 6.2.3 Ambient Monitoring – Results and Discussion

Twelve precipitation events greater than 0.1-inch depth were observed throughout the monitoring period (Table 17). Only one event produced observable ponding in the basin (Figure 34). On July 4 – 5, 2023, 0.53 inches of precipitation occurred over 5 hours, and the infiltration basin filled to a maximum depth of approximately 6 inches at the staff gauge. The ponded water infiltrated to a depth of about 2.5 inches within 30 minutes (Figure 35), indicating a saturated infiltration rate of approximately 5 inches/hour. The depth of ponded water could not be observed below 2.5 inches during this event due to vegetation obscuring the trail camera.



## Runoff Reduction Field Monitoring in Cherry Creek Basin

Notably, there were several other events with precipitation depths of 0.4 – 0.6 inches that did not result in any ponded water in the infiltration basin. Those events occurred over longer durations and were less intense than the July 4 – 5 event.



**Figure 34. Ponding observed at Lake Loop basin during the July 4 – 5, 2023, precipitation event**

**Table 17. Ponding in Lake Loop infiltration basin in response to precipitation events**

| Precipitation Event | Start Date | Precipitation Event Metrics |                |                            |                             | Ponding Present/Absent |
|---------------------|------------|-----------------------------|----------------|----------------------------|-----------------------------|------------------------|
|                     |            | Depth (in)                  | Duration (hrs) | 5-Minute Intensity (in/hr) | 60-Minute Intensity (in/hr) |                        |
| 1                   | 8/1/2023   | 0.10                        | 1.75           | 0.25                       | 0.09                        | Absent                 |
| 2                   | 8/27/2023  | 0.10                        | 6.75           | 0.12                       | 0.05                        | Absent                 |
| 3                   | 9/3/2023   | 0.11                        | 5.50           | 0.20                       | 0.08                        | Absent                 |
| 4                   | 7/21/2023  | 0.11                        | 0.58           | 0.50                       | 0.11                        | Absent                 |
| 5                   | 9/10/2023  | 0.26                        | 6.17           | 0.17                       | 0.10                        | Absent                 |
| 6                   | 8/25/2023  | 0.32                        | 10.75          | 0.41                       | 0.22                        | Absent                 |
| 7                   | 8/2/2023   | 0.37                        | 7.42           | 0.68                       | 0.31                        | Absent                 |
| 8                   | 7/31/2023  | 0.47                        | 10.67          | 0.43                       | 0.16                        | Absent                 |
| 9                   | 9/14/2023  | 0.48                        | 8.42           | 0.78                       | 0.20                        | Absent                 |
| 10                  | 7/20/2023  | 0.52                        | 15.92          | 0.77                       | 0.25                        | Absent                 |
| 11                  | 7/4/2023   | 0.53                        | 4.92           | 1.38                       | 0.31                        | Present                |
| 12                  | 6/29/2023  | 0.62                        | 9.00           | 1.40                       | 0.27                        | Absent                 |

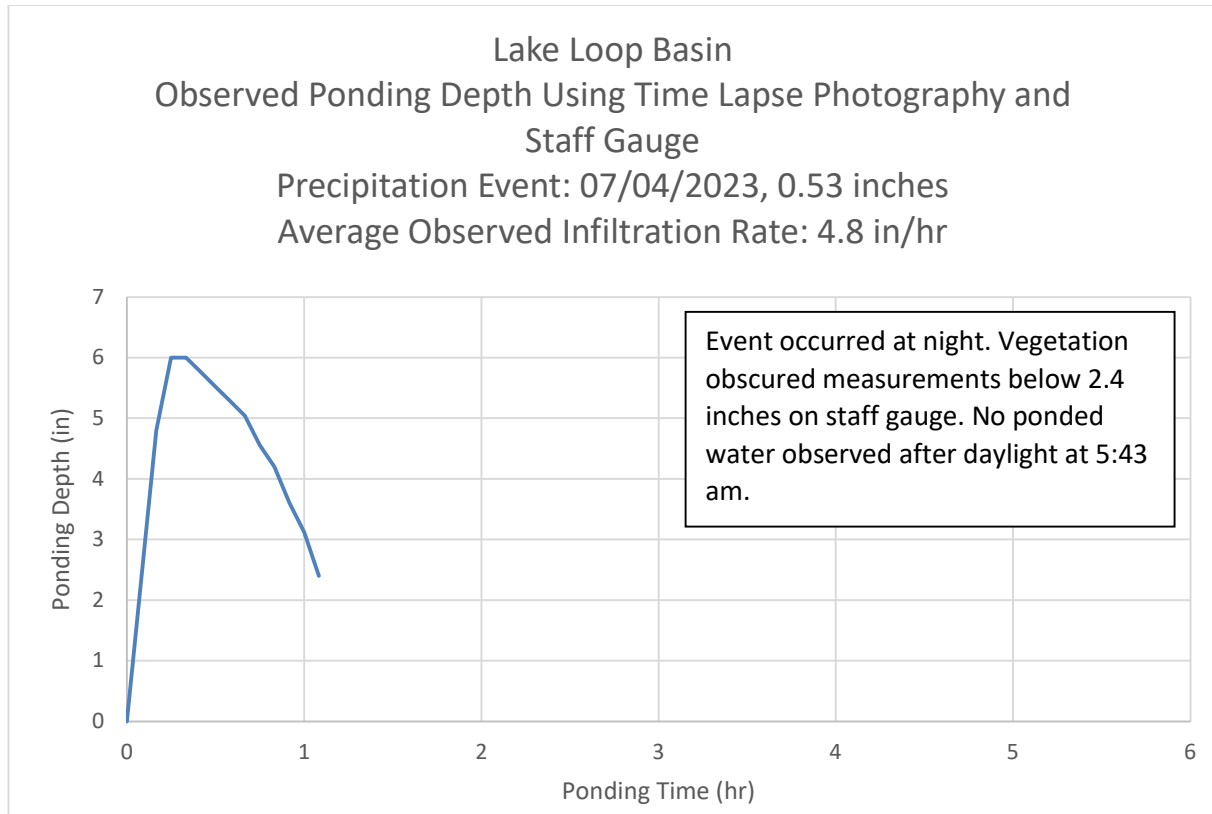

**Figure 35. Ponding event observed at Lake Loop basin on July 4, 2023**

### 6.2.4 Soil Sampling

Two 6-inch soil cores were collected at the Lake Loop site, one from the infiltration basin and the other from nearby native soil. Soil particle distribution analysis indicates primarily sandy soil, with less than 10% silts and clays (Figure 36) for both the native soil and the imported infiltration basin media. The infiltration basin soils are consistent with the soil specifications provided by Muller (2013). The native soil exhibits a slightly higher fraction of both gravel (>2.0 mm) and silts and clays (<0.075 mm) compared to the imported soil. Additional details regarding soil analysis, including sample locations and chemical analysis, can be found in Appendix 2.

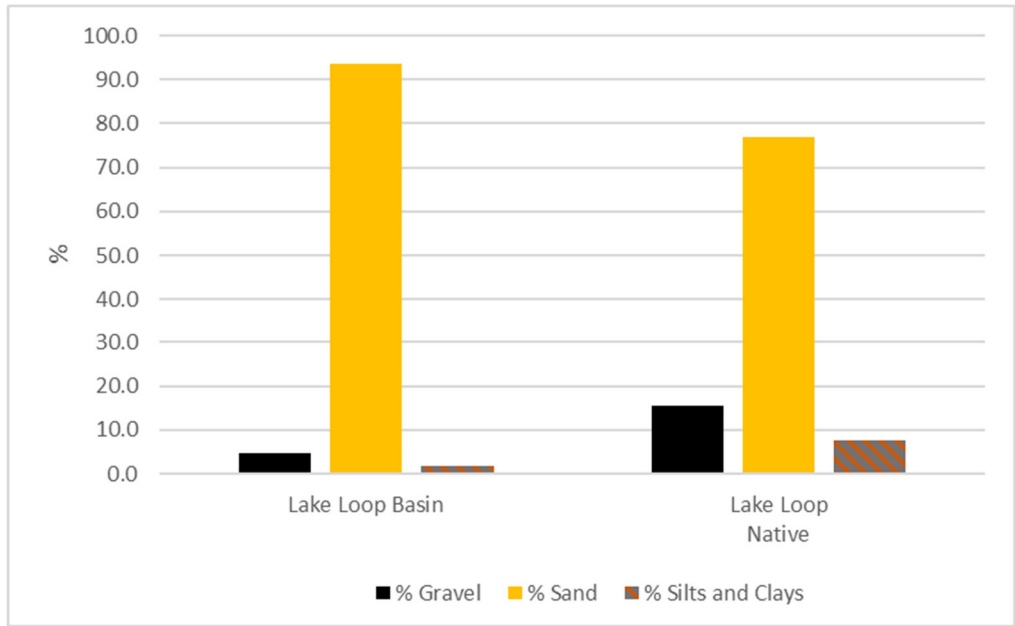
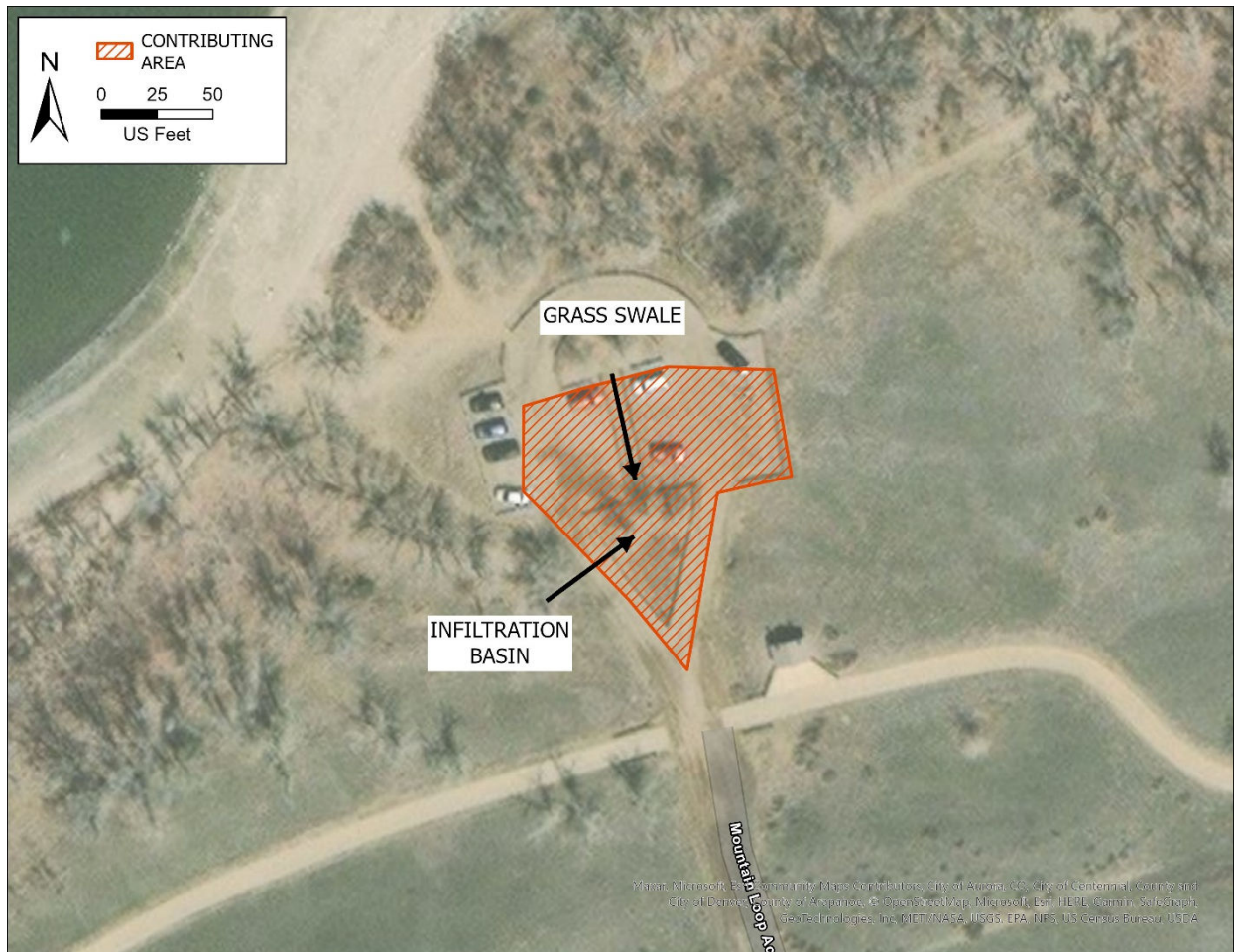

Figure 36. Soil particle size distribution at Lake Loop basin (per AASHTO soil particle size classification, 1970)

### 6.3 CCSP Mountain Loop Infiltration Basin/Swale

#### 6.3.1 Introduction

The Mountain Loop parking area in CCSP is a gravel parking lot with approximately 0.21 acres draining to a combination grass swale and infiltration basin (Figure 37). The Mountain Loop parking area was redesigned in 2013, and the grass swale and infiltration basin were installed at that time. Runoff captured by the grass swale discharges into the infiltration basin. The surface area of the infiltration basin is approximately 1,530 sf, and the surface area of the grass swale is approximately 560 sf. Although the parking lot is gravel (i.e., technically not “impervious”), it is highly compacted and considered to be impervious for purposes of this report. The UIA:RPA ratios are approximately 5:1 for the infiltration basin only and 3:1 for the combined swale and infiltration basin. The swale and infiltration basin are well vegetated with tall grasses and do not receive supplemental irrigation.



**Figure 37. Approximate Mountain Loop parking area draining to infiltration basin**

### 6.3.2 Ambient Monitoring Methods

The infiltration basin and swale were monitored using trail cameras programmed to take a photograph every 5 minutes, 24 hours per day. Staff gauges were also installed to document the depth of ponded water during precipitation events (Figure 38 and Figure 39). The cameras and staff gauges were installed on June 28, 2023 and removed November 1, 2023. Due to technical issues with the camera, no photos were taken of the swale from August 11, 2023 through September 26, 2023. Precipitation event data were collected and analyzed as described in previous sections of this report.





**Figure 38. Camera installed adjacent to Mountain Loop swale with staff gauge**

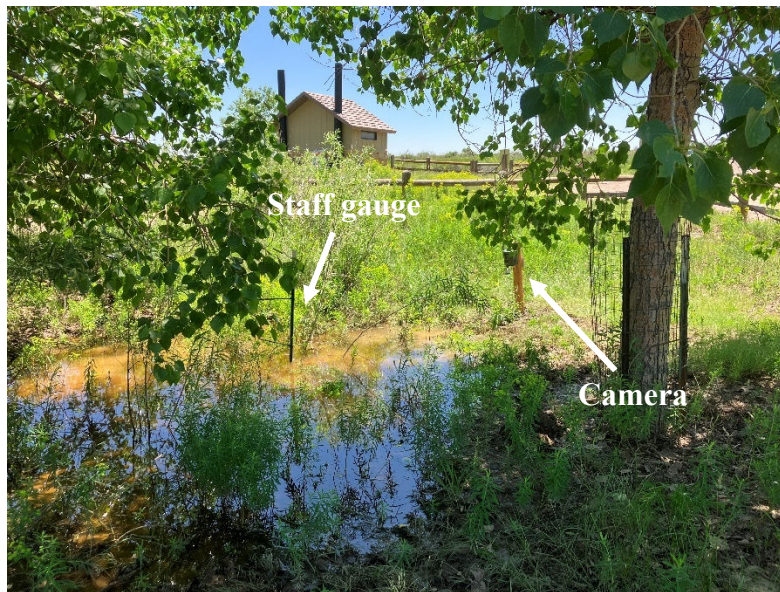

**Figure 39. Installation of camera and staff gauge in Mountain Loop basin with ponded water visible**

Photos were reviewed for presence of ponding in the infiltration basin or flow in the swale (Figure 40) during the period surrounding each precipitation event greater than 0.1-inch depth. If ponding occurred in the basin with a precipitation event, the depth of ponding observed in each 5-minute photo was recorded. The overall infiltration rate was then estimated by observing the decreasing water level on the staff gauge from the time of peak depth to full infiltration.

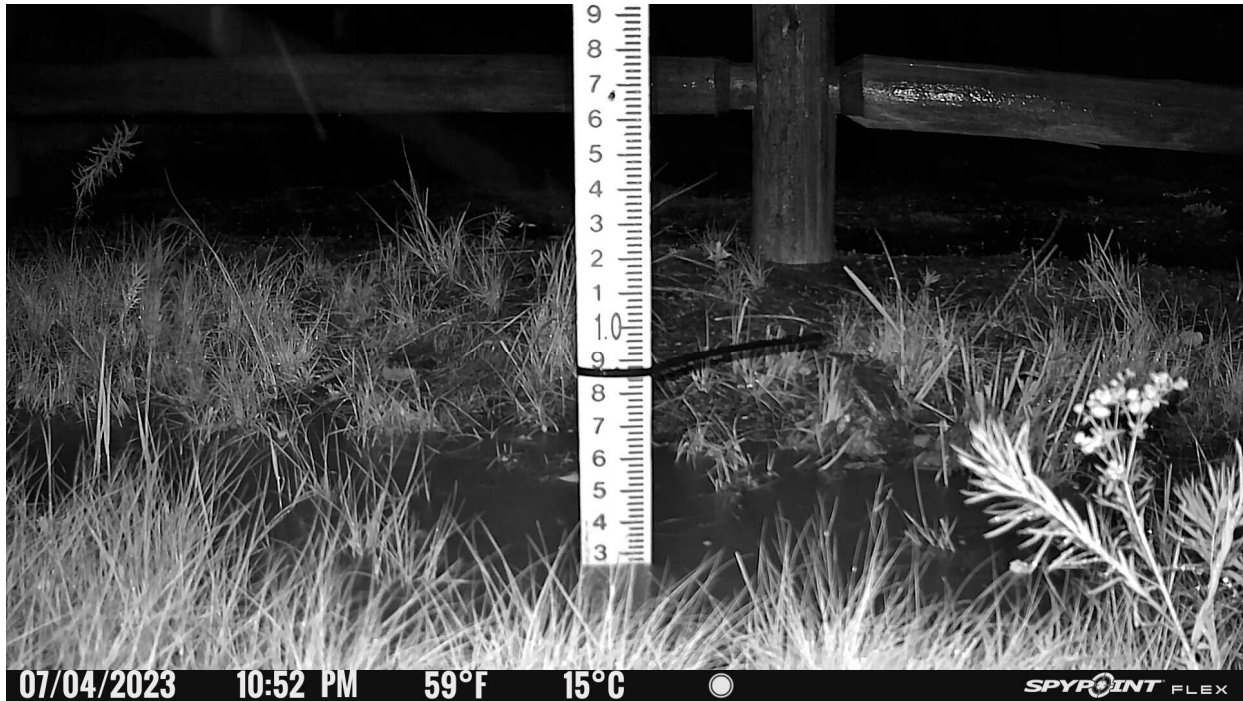

Figure 40. Observable runoff at the Mountain Loop swale

### 6.3.3 Ambient Monitoring – Results and Discussion

Ten precipitation events exceeding 0.1 inches were recorded throughout the monitoring period at the basin and ponding was observed during seven of those events (Table 18). The maximum water depth in the basin observed was 13.2 inches in response to 0.63 inches of precipitation on July 4 – 5, 2023 (Figure 41). This precipitation depth is close to the WQCV precipitation depth. With the exception of a 0.12-inch event on July 18, all of the precipitation events producing ponding in the basin were of 0.4-inch depth or greater. The July 18 event had a 5-minute intensity of almost 0.5 inches/hour, which may explain why ponding occurred as a result of this event, but not others of similar depth and lower intensity.



## Runoff Reduction Field Monitoring in Cherry Creek Basin

**Table 18. Precipitation metrics and ponding absence/presence at the Mountain Loop infiltration basin**

| Date      | Precipitation Event Metrics |                |                            |                             | Ponding Present/Absent |
|-----------|-----------------------------|----------------|----------------------------|-----------------------------|------------------------|
|           | Depth (in)                  | Duration (hrs) | 5-Minute Intensity (in/hr) | 60-Minute Intensity (in/hr) |                        |
| 8/27/2023 | 0.11                        | 6.50           | 0.18                       | 0.06                        | Absent                 |
| 7/18/2023 | 0.12                        | 6.50           | 0.48                       | 0.10                        | Present                |
| 9/3/2023  | 0.16                        | 5.50           | 0.31                       | 0.10                        | Absent                 |
| 9/14/2023 | 0.38                        | 8.75           | 0.34                       | 0.17                        | Absent                 |
| 8/2/2023  | 0.41                        | 6.50           | 0.80                       | 0.36                        | Present                |
| 8/25/2023 | 0.45                        | 10.75          | 0.50                       | 0.26                        | Present                |
| 7/31/2023 | 0.45                        | 13.17          | 0.23                       | 0.14                        | Present                |
| 7/4/2023  | 0.63                        | 4.92           | 2.45                       | 0.39                        | Present                |
| 6/29/2023 | 0.68                        | 9.00           | 1.97                       | 0.36                        | Present                |
| 7/20/2023 | 0.68                        | 15.83          | 1.09                       | 0.25                        | Present                |

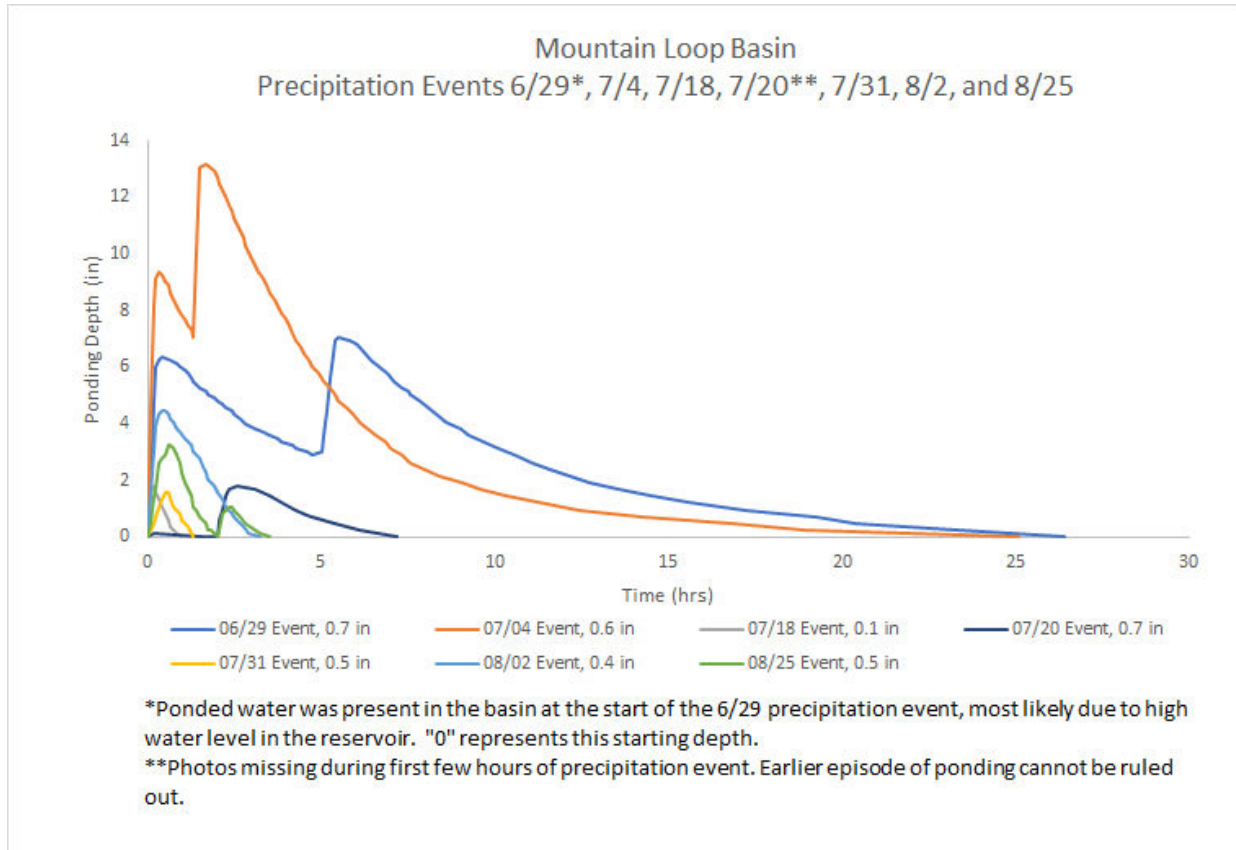

**Figure 41. Ponding observed in the Mountain Loop infiltration basin on July 5, 2023**

Based on all seven events with measurable ponding depth, the overall infiltration rate ranged from 0.3 – 2.4 in/hr (Figure 42 and Table 19). The infiltration rate for the June 29 event was likely affected by the water surface elevation of the Cherry Creek Reservoir. The water surface elevation

## Runoff Reduction Field Monitoring in Cherry Creek Basin

on June 29 was approximately 5,553 feet,<sup>14</sup> which is the same elevation as the bottom of the infiltration basin (Muller, 2013).



**Figure 42. Pounding in Mountain Loop infiltration basin in response to precipitation events**

**Table 19. Precipitation, ponding, and infiltration rates measured at the Mountain Loop infiltration basin**

| Date      | Precipitation Depth (in) | Maximum Pounding Depth (in) | Duration of Pounding (hrs) | Infiltration Rate (in/hr) |
|-----------|--------------------------|-----------------------------|----------------------------|---------------------------|
| 7/18/2023 | 0.12                     | 1.8                         | 1.0                        | 2.2                       |
| 8/2/2023  | 0.41                     | 4.4                         | 3.2                        | 1.6                       |
| 8/25/2023 | 0.45                     | 3.2                         | 3.5                        | 2.4                       |
| 7/31/2023 | 0.45                     | 1.6                         | 1.3                        | 2.1                       |
| 7/4/2023  | 0.63                     | 13.2                        | 25.1                       | 0.6                       |
| 6/29/2023 | 0.68                     | 7.1                         | 26.4                       | 0.3                       |
| 7/20/2023 | 0.68                     | 1.8                         | 7.2                        | 0.4                       |

<sup>14</sup> <https://dwr.state.co.us/Tools/Stations/CHRRESCO?params=ELEV>

6.3.4 Soil Sampling

Two 6-inch soil cores were collected at both the Mountain Loop basin and swale at depths 0 – 6” and 6 – 12”. Another soil core was collected from “native” soils nearby. Figure 43 and Figure 44 show the soil particle distributions of those soil cores. The soil samples within the basin and swale are generally consistent with the “sandy loam” media specified in the design drawings (Muller, 2013). The native soil is very similar to the imported media, with slightly higher fractions of gravels, silts, and clays. Additional details regarding soil analysis, including sampling locations and soil chemical analysis, can be found in Appendix 2.

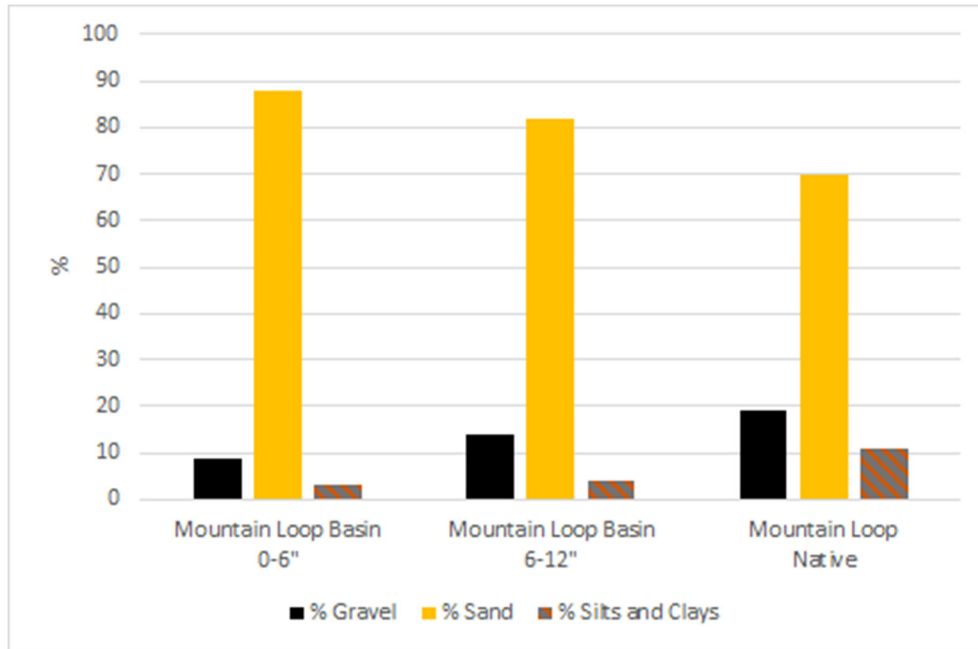

Figure 43. Soil particle size distribution at Mountain Loop infiltration basin (per AASHTO soil particle size classification, 1970)

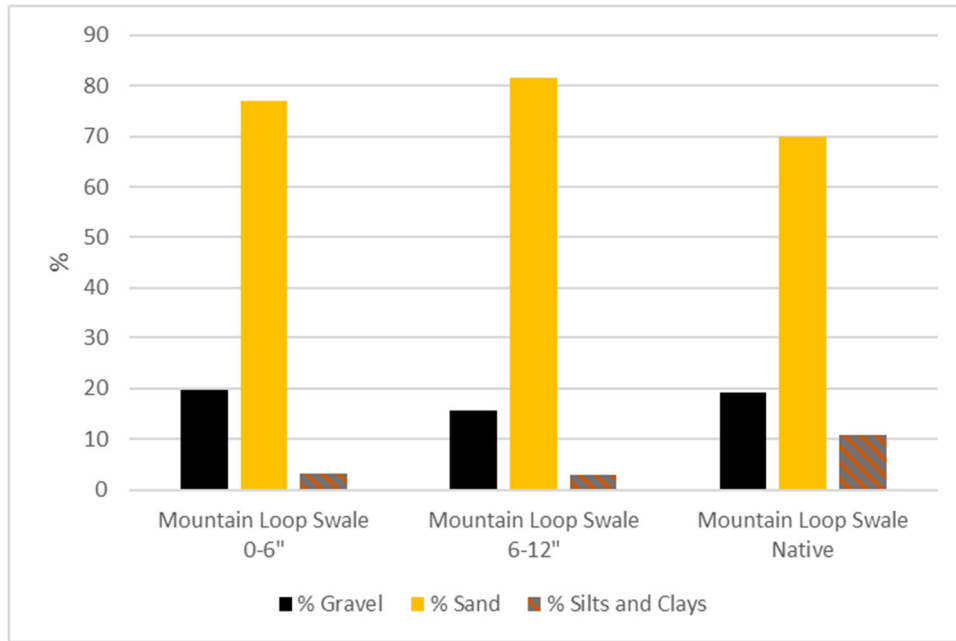

Figure 44. Soil particle size distribution at Mountain Loop swale (per AASHTO soil particle size classification, 1970)

## 6.4 17 Mile House Farm Park

### 6.4.1 Introduction

The 17 Mile House Farm Park is located at 8181 S. Parker Road in unincorporated Arapahoe County. The open space area, owned by Arapahoe County, lies between Cherry Creek to the west and S. Parker Road to the east. A natural depression exists between S. Parker Road and the dirt access road to the parking area (Figure 45). This natural, non-engineered infiltration basin occupies an area of approximately 1,000 sf and consists of Hydrologic Soil Group (HSG) Type B soils, per Natural Resources Conservation Service (NRCS) data. Vegetation in the basin includes tall grasses, weeds, and several mature evergreen trees and does not receive supplemental irrigation.

This site was selected for monitoring to evaluate the performance of relatively undisturbed, naturally-occurring depressions that essentially operate as infiltration basins. The proximity of a fire hydrant less than 50 feet away was also a factor in site selection.





**Figure 45. 17 Mile House infiltration basin**

### 6.4.2 Summary of SRTs

Four SRTs were conducted in October and November 2023 (Figure 46), with each SRT having a total inflow volume of approximately 8,200 – 8,400 gallons applied at a rate between 350 – 400 gpm (Table 20). The inflow rates and volumes used do not represent a particular design event specific to the site. The inflow rates were set to discharge at the maximum rate that could safely be handled by field staff (to fill the basin as fast as possible) and the inflow volumes are the result of stopping the tests once the deepest portions of the basin were filled to several inches of water.

Immediately after inflows were stopped, the maximum extent of the water surface (i.e., wetted perimeter) was marked using utility flags placed approximately every 2 – 3 feet.

A Trimble DA2 Catalyst GNSS unit was used to record horizontal and vertical coordinates (i.e., GPS points) of the water surface perimeter after each test. The GPS points were then analyzed in GIS to generate a wetted surface area for each SRT.

A staff gauge was installed in the basin to measure water levels in the basin during the SRTs. Those measurements were used to estimate infiltration rates and verify other field measurements.



**Figure 46. SRT at 17 Mile House infiltration basin**

**Table 20. Summary of SRTs completed at 17 Mile House infiltration basin**

| <b>Date</b>      | <b>Inflow Rate<br/>(gpm)</b> | <b>Inflow Volume<br/>(gal)</b> | <b>Duration of Inflow<br/>(min)</b> |
|------------------|------------------------------|--------------------------------|-------------------------------------|
| October 9, 2023  | 370                          | 8,170                          | 22                                  |
| October 17, 2023 | 350                          | 8,410                          | 24                                  |
| October 26, 2023 | 400                          | 8,370                          | 21                                  |
| November 1, 2023 | 390                          | 8,220                          | 21                                  |

**6.4.3 SRTs – Results and Discussion**

The maximum wetted surface area delineated during the SRTs ranged from 630 – 910 sf (Figure 47). Staff gauge measurements showed that all water was infiltrated within 10 – 15 minutes after inflows were stopped (Figure 48).

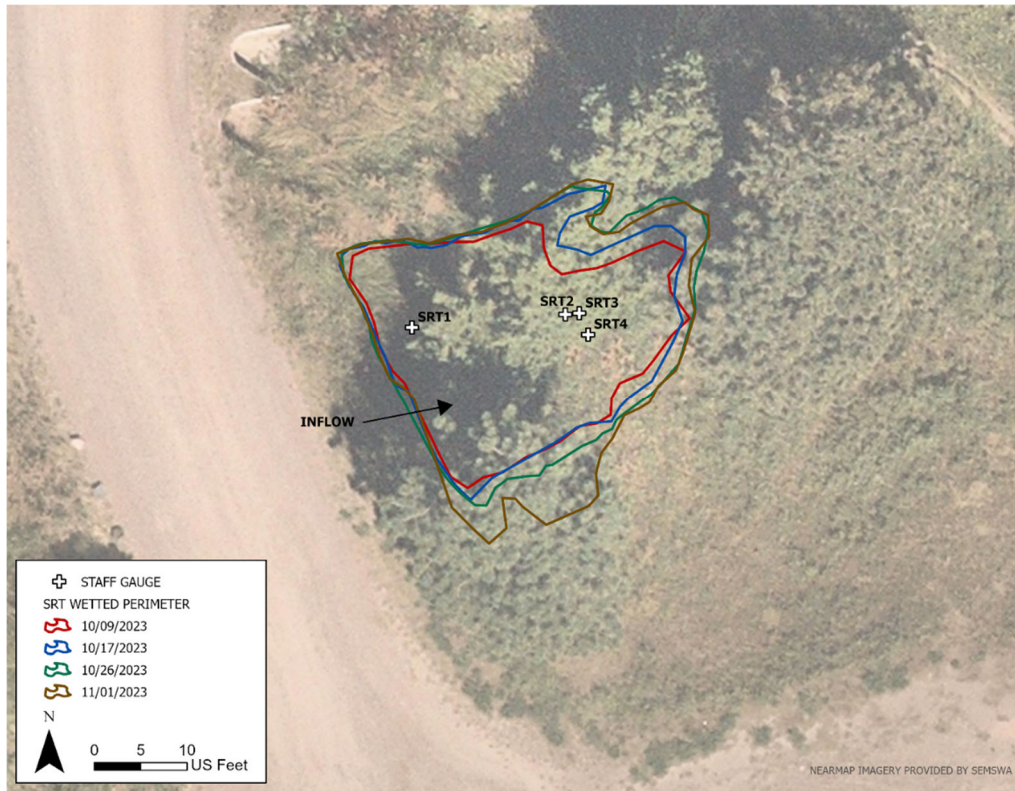

Figure 47. Wetted perimeter following four SRTs at 17 Mile House infiltration basin



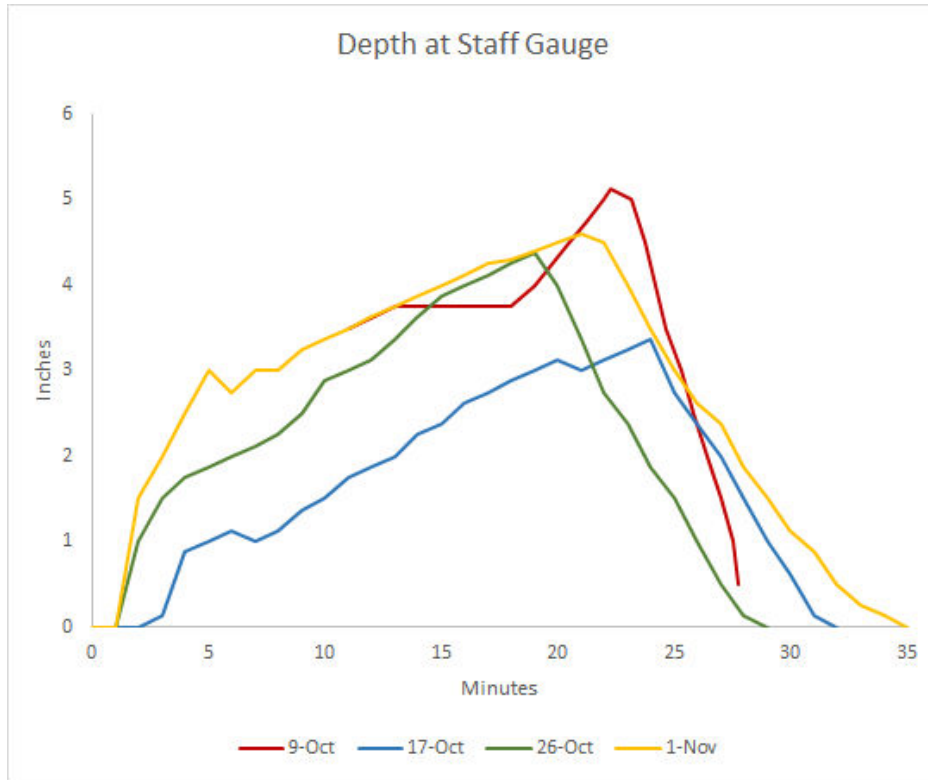

Figure 48. Depth measured at the staff gauge throughout SRTs at 17 Mile House infiltration basin

## Runoff Reduction Field Monitoring in Cherry Creek Basin

---

The overall infiltration rates ranged from 25 – 45 in/hr (Table 21). These rates were calculated using the total inflow volume, the total wetted surface area, and the duration from the start of the SRTs to the time when all water was infiltrated. The infiltration rates measured from the staff gauge were generally lower than the overall infiltration rates as they only represented the infiltration rates at the end of the SRTs.

**Table 21. Infiltration rates calculated from the SRTs**

| Date             | Inflow Volume (gal) | Overall Infiltration Rate (in/hr) | Staff Gauge Infiltration Rate (in/hr) |
|------------------|---------------------|-----------------------------------|---------------------------------------|
| October 9, 2023  | 8,170               | 45                                | 51                                    |
| October 17, 2023 | 8,410               | 35                                | 26                                    |
| October 26, 2023 | 8,370               | 33                                | 26                                    |
| November 1, 2023 | 8,220               | 25                                | 20                                    |

The results were also analyzed to put the infiltration basin performance in context for design. The inflow volumes for each SRT were used to determine the UIA that would produce an equivalent runoff volume for the water quality event.<sup>15</sup> The RPA is then equal to the wetted surface area for each SRT. The results suggest that this basin could meet the Runoff Reduction Standard with a UIA:RPA ratio of approximately 30:1 or less.

| Date             | Inflow Volume (gal) | UIA Equivalent (acres) | RPA (acres) | UIA:RPA |
|------------------|---------------------|------------------------|-------------|---------|
| October 9, 2023  | 8,170               | 0.60                   | 0.014       | 42:1    |
| October 17, 2023 | 8,410               | 0.62                   | 0.017       | 38:1    |
| October 26, 2023 | 8,370               | 0.62                   | 0.019       | 32:1    |
| November 1, 2023 | 8,220               | 0.61                   | 0.021       | 29:1    |

### 6.4.4 Soil Analysis

Two 6-inch soil cores were collected from the 17 Mile House infiltration basin. The soil texture analysis indicates sandy clay loam soil at both 0 – 6 and 6 – 12-inch depths (Figure 49). These soils have a lower sand content and higher silt/clay content than the MHFD’s specifications for bioretention filter media.

---

<sup>15</sup> UIA for the water quality event is calculated as the Inflow Volume divided by 0.5 inches of runoff

## Runoff Reduction Field Monitoring in Cherry Creek Basin

---

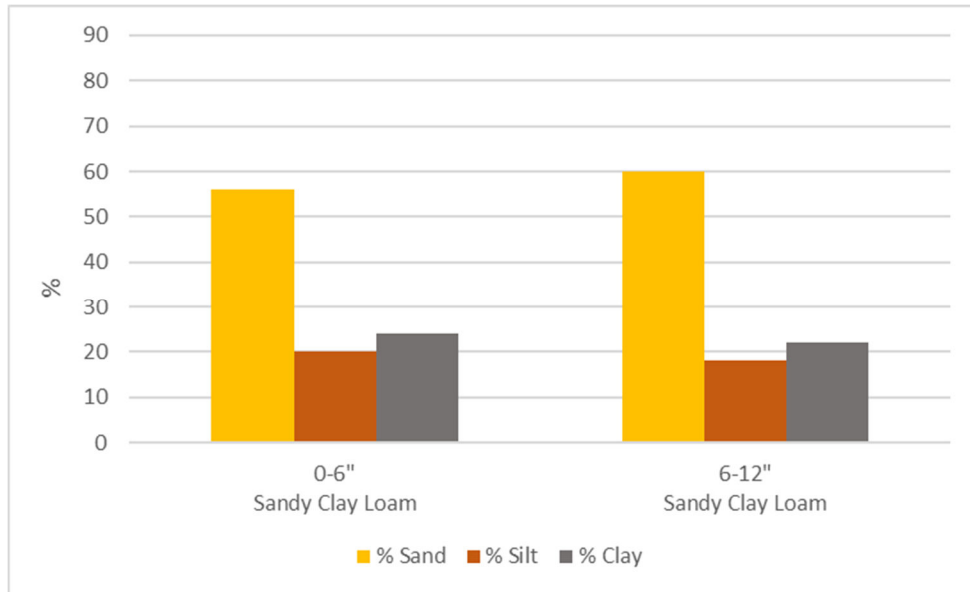

**Figure 49. Soil texture analysis of 17 Mile House infiltration basin**



## 7.0 GRASS/VEGETATED BUFFERS

### 7.1 Introduction

Two different sites representative of non-engineered grass/vegetated buffers were monitored using SRTs in October and November 2023. These sites were not designed or constructed as buffers for any particular development project, but were selected for monitoring due to their location, proximity to fire hydrants and characteristics that reasonably represent buffer features.

One of the buffers is located at the 17 Mile House site (Figure 50). This buffer is mostly undisturbed undeveloped area, with tall grasses and no supplemental irrigation (Figure 51).<sup>16</sup> The NRCS Web Soil Survey (WSS) indicates the soils are HSG B soils.

The second buffer is located in Parker, directly east and across Pikes Peak Avenue from the Town of Parker Town Hall (Figure 52). Based on historic aerial imagery, this site has remained relatively undisturbed since circa 2000, when it may have served as a staging area for construction of the Parker Town Hall. It is poorly vegetated, with clumps of short vegetation interspersed with exposed soils (Figure 53). The NRCS WSS indicates the soils are HSG B soils; however, the soils are likely compacted urban soils.

---

<sup>16</sup> Aerial imagery shows historical agricultural use prior to 2017.





# Runoff Reduction Field Monitoring in Cherry Creek Basin



**Figure 52. Parker Town Hall grass buffer site**



**Figure 53. Parker Town Hall grass buffer**

# Runoff Reduction Field Monitoring in Cherry Creek Basin

## 7.2 Summary of SRTs

Four SRTs were performed at the 17 Mile House buffer, and two SRTs were performed at the Parker Town Hall buffer in October and November 2023 (Table 22). The inflow volumes and rates were not based on any specific design storm criteria for the sites since they do not have a defined contributing area. Instead, the inflow rates and volumes were adjusted based on site conditions and the ability to generate runoff over a relatively large area in a reasonable amount of time.

**Table 22. Summary of SRTs at 17 Mile House and Parker Town Hall grass buffers**

| Date             | 17 Mile House Grass Buffer |                 | Parker Town Hall Grass Buffer |                 |
|------------------|----------------------------|-----------------|-------------------------------|-----------------|
|                  | Application Rate (gpm)     | Volume In (gal) | Application Rate (gpm)        | Volume In (gal) |
| October 9, 2023  | 50                         | 1,100           | N/A                           | N/A             |
| October 17, 2023 | 50                         | 1,100           | 60                            | 1,200           |
| October 26, 2023 | 80                         | 1,700           | N/A                           | N/A             |
| November 1, 2023 | 100                        | 1,500           | 60                            | 1,300           |

Immediately after inflows were stopped, the maximum extent of the water surface (i.e., wetted perimeter) was marked using utility flags placed approximately every 2 – 3 feet. GPS points were collected at each flag location using a Trimble DA2 Catalyst GNSS unit (Figure 54) and were processed in GIS to calculate the total wetted perimeter and surface area for each SRT.



**Figure 54. WVE staff collecting GPS data around the wetted perimeter following SRT**

## 7.3 SRT – Results and Discussion

The four SRTs at the 17 Mile House buffer generated wetted surface areas ranging from approximately 150 – 380 sf (Figure 55) and estimated infiltration rates ranging from 15 – 32 in/hr (Table 23). After the first SRT, the test location was moved to a new area that had more consistent



## Runoff Reduction Field Monitoring in Cherry Creek Basin

lateral and longitudinal slopes. The final SRT (November 1, 2023) was performed a few days after a snow event and soils may have been more saturated than the other tests. The GIS analysis of GPS points indicated an average buffer slope of approximately 3.6%.

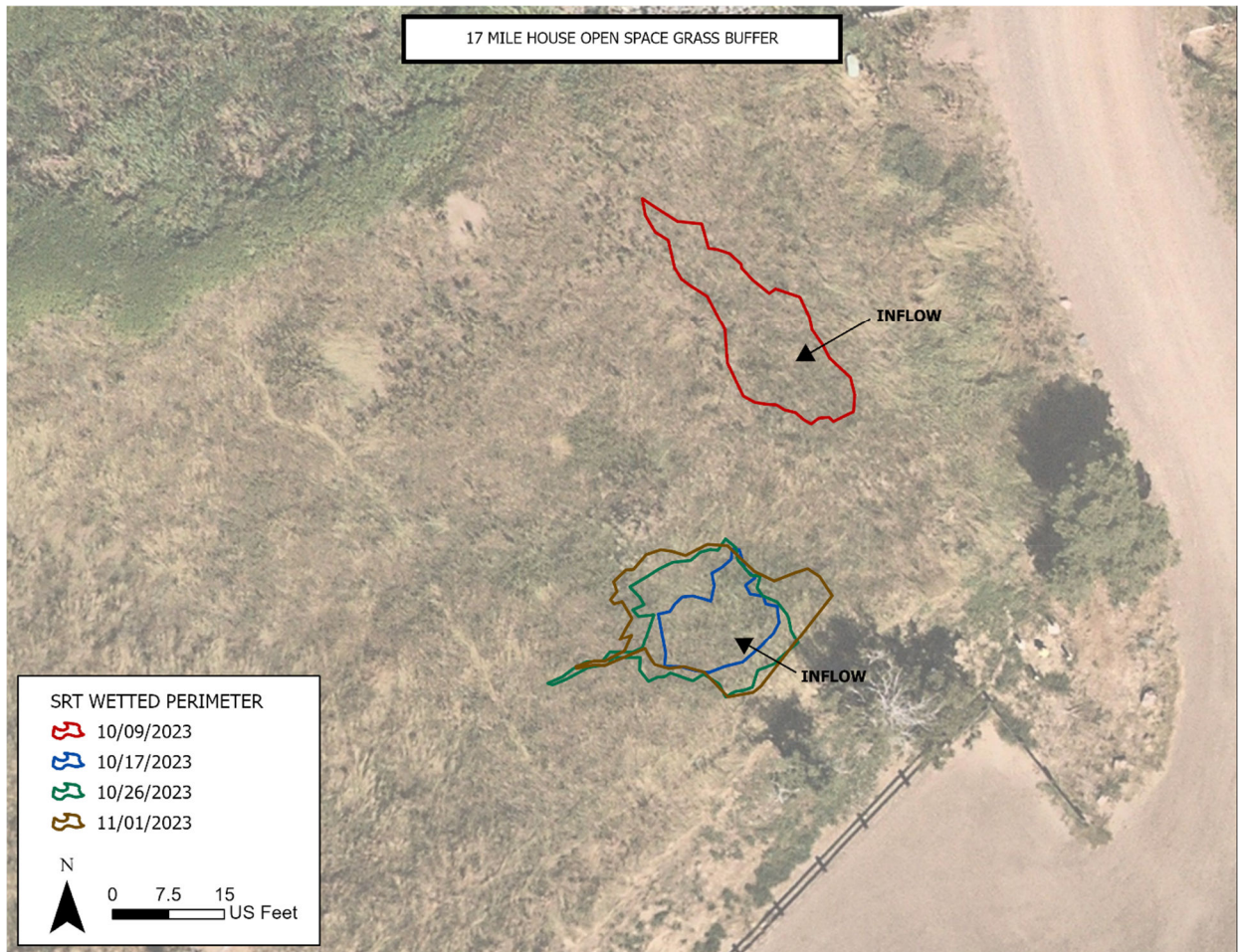

**Figure 55. Wetted perimeter following SRTs at 17 Mile House grass buffer**

**Table 23. Results of SRTs performed at 17 Mile House grass buffer**

| Date             | Inflow Volume (gal) | SRT Duration (min) | Wetted Surface Area (sf) | Average Infiltration Rate (in/hr) |
|------------------|---------------------|--------------------|--------------------------|-----------------------------------|
| October 9, 2023  | 1,100               | 23                 | 300                      | 15                                |
| October 17, 2023 | 1,100               | 21                 | 150                      | 32                                |
| October 26, 2023 | 1,700               | 20                 | 300                      | 27                                |
| November 1, 2023 | 1,500               | 15                 | 400                      | 24                                |

The two SRTs at the Parker Town Hall buffer site generated wetted surface areas of 1,000 – 1,100 sf (Figure 56) and estimated infiltration rates ranging from 5.4 – 5.8 in/hr (Table 24). The GIS analysis of GPS points indicated an average buffer slope of approximately 3.3%.



# Runoff Reduction Field Monitoring in Cherry Creek Basin



**Figure 56. Wetted perimeter following SRTs at Parker Town Hall buffer**

**Table 24. Results of SRTs performed at the Parker Town Hall buffer**

| Date             | Inflow Volume (gal) | SRT Duration (min) | Wetted Surface Area (sf) | Average Infiltration Rate (in/hr) |
|------------------|---------------------|--------------------|--------------------------|-----------------------------------|
| October 17, 2023 | 1,200               | 20                 | 1,000                    | 5.8                               |
| November 1, 2023 | 1,300               | 21                 | 1,100                    | 5.4                               |

To put these results into context for buffer design and planning purposes, we performed another set of calculations to determine the UIA:RPA ratio that would result in 100% runoff reduction from these sites.

## Runoff Reduction Field Monitoring in Cherry Creek Basin

---

The inflow volumes for each SRT were used to determine the UIA that would produce an equivalent runoff volume for the water quality event.<sup>17</sup> The RPA is then equal to the wetted surface area for each SRT. Results are presented in Table 25.

**Table 25. UIA:RPA ratios that would provide 100% runoff reduction based on SRT results**

| Date                       | Inflow Volume<br>(gal) | UIA Equivalent<br>(acres) | RPA<br>(acres) | UIA:RPA |
|----------------------------|------------------------|---------------------------|----------------|---------|
| Site: 17 Mile House Buffer |                        |                           |                |         |
| October 9, 2023            | 1,100                  | 0.08                      | 0.007          | 12:1    |
| October 17, 2023           | 1,100                  | 0.08                      | 0.003          | 24:1    |
| October 26, 2023           | 1,700                  | 0.13                      | 0.007          | 18:1    |
| November 1, 2023           | 1,500                  | 0.11                      | 0.009          | 12:1    |
| Site: Parker Town Hall     |                        |                           |                |         |
| October 17, 2023           | 1,200                  | 0.09                      | 0.023          | 4:1     |
| November 1, 2023           | 1,300                  | 0.10                      | 0.025          | 4:1     |

### 7.4 Soil Analysis

Two 6-inch soil cores were collected from both sites and submitted to the Colorado State University SPUR Soil, Water and Plant Testing Laboratory for analysis (Figure 57 and Figure 58). The soil texture at both sites is classified as “sandy loam,” with the percent sand content exceeding 60%. The silt/clay content at the 17 Mile House buffer was slightly higher than the Parker Town Hall site. The full soil analysis reports are provided in Appendix 2.

---

<sup>17</sup> UIA for the water quality event is calculated as the Inflow Volume divided by 0.5 inches of runoff.

# Runoff Reduction Field Monitoring in Cherry Creek Basin

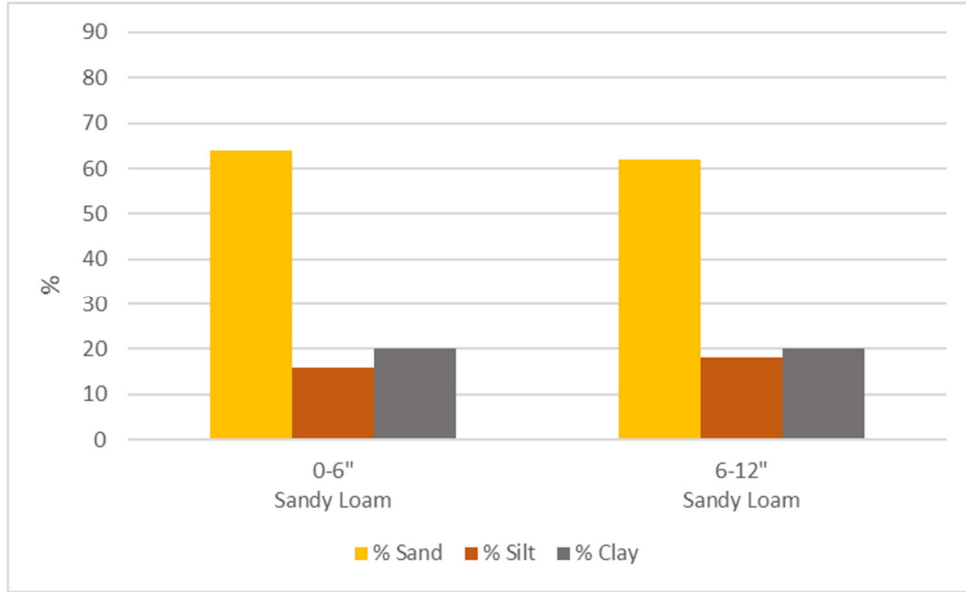

**Figure 57. Soil texture analysis of 17 Mile House buffer**

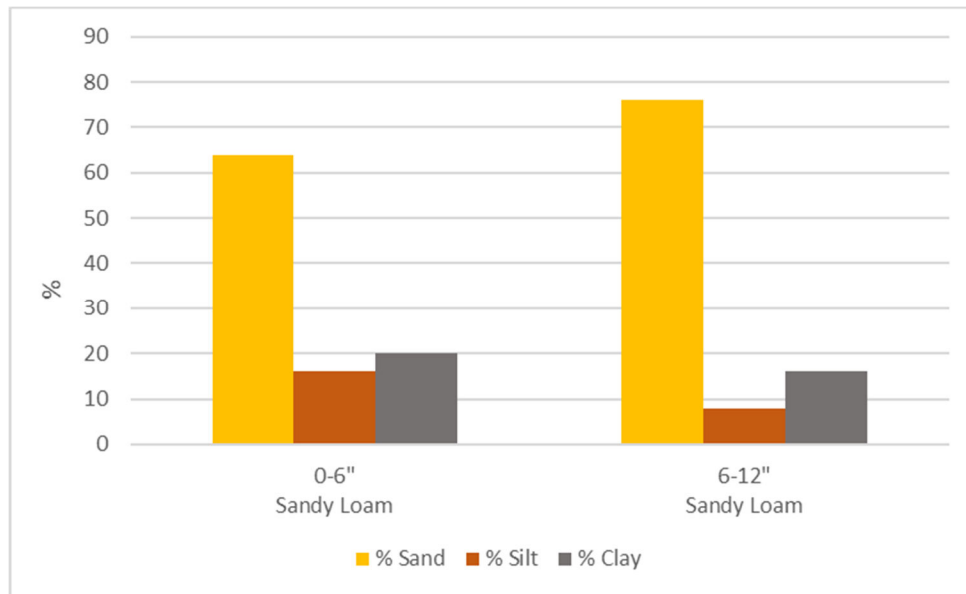

**Figure 58. Soil texture analysis of Parker Town Hall buffer**

## 8.0 SUMMARY AND CONCLUSIONS

### 8.1 Engineered Grass Swales with Underdrains

SRT monitoring results for two of the four engineered swales showed measurable reductions of runoff volume. The SEMSWA swale reduced runoff volume by 20-40% and the Central Centennial swale reduced runoff volumes by 50-70%. The SEMSWA results were generated using inflow volumes roughly equivalent to the WQCV and the Central Centennial results were generated using inflows equal to or greater than the WQCV. Based on these results, it appears the Central Centennial swale could meet the Runoff Reduction Standard.

Ambient monitoring results at the SEMSWA swale showed underdrain discharges for every precipitation event exceeding 0.1 inches. For the Central Centennial swale, the threshold for generating underdrain discharge was about 0.15 inches. Both sites are heavily irrigated, so the soils likely remain close to saturated conditions throughout the irrigation season. The underdrain discharges were not quantified for each storm event; however, it is probable that some runoff reduction occurred.

The RoadSafe swale did not perform as expected. As is, the RoadSafe swale only captured and infiltrated approximately 400 gallons of inflow, which is about 10% of the WQCV for the swale contributing area. However, additional SRTs conducted using sandbags to simulate check dams improved the swale's performance. Placing three sandbags at 25-foot increments resulted in approximately 900 gallons of inflow being captured and infiltrated, and placing four sandbags at 25-foot increments resulted in nearly 1,200 gallons of inflow being captured and infiltrated. These improved performance volumes are 25% and 32% of the WQCV.

Very little underdrain discharge was observed during the SRTs at the RoadSafe site. To verify that the underdrain was not clogged, SEMSWA CCTV'd the underdrain and determined that it was clear of sediment and debris. WWE concludes that the following factors likely affected poor infiltration in the swale:

- Surface clogging is present in the swale, potentially exacerbated by backfilling the underdrain with native (not amended) soils.
- While collecting soil cores, field staff observed a thin (<1 inch) layer of sediment buildup at the swale surface. This layer contributed to a restricted surface infiltration rate.
- Field staff observed a layer of clayey soil approximately 11 – 12 inches below the surface and 4 – 6 inches above the underdrain. This observation is not consistent with the design drawings that called for amended media down to the underdrain and could also restrict infiltration to the underdrain.

## Runoff Reduction Field Monitoring in Cherry Creek Basin

---

Lastly, the presence of underdrain discharge during ambient monitoring at RoadSafe is likely due to inflows “short-circuiting” to the underdrain near the inflow pipe.<sup>18</sup>

The Smith & Smith swale also did not perform as expected, and inflow did not readily infiltrate into the underlying soils, with very little discharge observed in the underdrain during SRTs. The SRT results demonstrated that approximately 1,600 gallons of inflow could be retained within the swale and slowly infiltrated over time. This is approximately 27% of the WQCV for the contributing area to the swale. The most plausible explanation for this finding is that the swale has a very low longitudinal slope and slight variations in the slope created relatively large areas of ponded water. These variations had a similar effect as the sandbag check dams used at the RoadSafe site.

Discharge was present at the Smith & Smith outlet structure for most precipitation events exceeding 0.1 inches. Most of the observed discharge entered the outlet structure as surface overflow rather than underdrain discharge. Three events that did not produce surface overflow or underdrain discharge had total rainfall depths of 0.16, 0.18, and 0.25 inches. The very low infiltration rates and lack of underdrain discharge is very likely due to incorrect swale construction. Soils analysis indicated the top 12” of swale soils have clay content exceeding 30% and sand content less than 50%. This is not consistent with the design drawings that reference the MHFD bioretention “growing media” and “filter media.” In addition, the invert of the swale appears to mostly be contained within the rock mulch area that was intended to serve as a buffer. This rock mulch area also has weed barrier installed that certainly would limit infiltration.

### 8.2 Minimally Engineered and Non-Engineered Infiltration Basins

Three infiltration basins were monitored for this Project. Two of the infiltration basins, located within CCSP, were “minimally-engineered” with some minor grading work and import of sandy loam filter media. The third infiltration basin, located at 17 Mile House, is a non-engineered infiltration basin that is a naturally-occurring depression. It was not specifically designed to function as an infiltration basin, but effectively serves as such.

The CCSP basins (“Mountain Loop and Lake Loop”) were monitored for ambient precipitation responses only.

The Lake Loop basin completely captured and infiltrated runoff generated from all precipitation events ranging in depth from 0.1 – 0.62 inches. There was only one event (July 4 – 5, 2023) where ponding was observed greater than about 2 inches and all water had infiltrated within a few hours after the end of rainfall. The estimated infiltration rate for this event was 5 in/hr. The estimated UIA:RPA for the Lake Loop basin is 9:1.

The Mountain Loop basin also has a relatively small vegetated swale upstream of the basin, and both function in combination to collect and infiltrate runoff. Most precipitation events generated

---

<sup>18</sup> This is discussed in more detail in Section 5.3.



## Runoff Reduction Field Monitoring in Cherry Creek Basin

---

ponded water in the basin. The maximum ponded depth of 13 inches occurred during the July 4 – 5, 2023 event. For all events, all runoff had infiltrated within 20 – 25 hours after rainfall stopped, and the estimated infiltration rates ranged from 0.3 – 2.4 in/hr. The estimated UIA:RPA for the basin and swale combination is 3:1 and the basin-only is 5:1.

The soils analysis for the CCSP sites provide good insight into the need for importing filter media for infiltration basins. The gradation of soil samples collected within the infiltration basins and Mountain Loop swale were very similar to the gradation of soil samples collected from nearby “native” soils. This suggests that infiltration basins may not require import of other filter media in some areas of the Cherry Creek Basin, however this should always be verified through soil analysis.

The 17 Mile House infiltration basin was monitored via four SRTs. SRT results showed infiltration rates ranging from 25 – 50 in/hr and all water was fully infiltrated within 10 – 15 minutes after inflows were stopped. Since this site was not designed to capture runoff from a particular contributing area, the SRT inflow volumes were used to determine an “equivalent UIA” that would have produced the inflow volumes for the water quality event. The RPA was estimated based on the wetted surface area after each test. Results show this basin effectively provided 100% runoff volume reduction with a UIA:RPA ratio of at most 42:1. The soil analysis results indicate the native soils are sandy clay loam, with approximately 50 – 60% sands and 20% clays. Sandy clay loam generally falls within hydrologic soil group Type C and the NRCS Soil Survey map for this site indicated HSG Type B. Clearly, the infiltration capacity of this basin exceeds what would otherwise be assumed based on these data sources. The plausible explanation is that this basin has been relatively undisturbed (i.e., soils not compacted) for several decades and is well-vegetated with tall grasses and mature trees that have root structures that promote infiltration.

### 8.3 Non-Engineered Grass/Vegetated Buffers

Two grass/vegetated buffers were monitored using SRTs. One buffer was located at the 17 Mile House site and the other was located near Parker Town Hall. Neither buffer was designed or constructed to receive runoff from a specific contributing area; however, they have characteristics that are reasonably representative of buffers that could be used as RPAs.

The estimated infiltration rates at the 17 Mile House buffer were 15 – 32 in/hr and at the Parker Town Hall buffer were 5 – 6 in/hr. Both buffers had longitudinal slopes of 3 – 4%, had soils classified as HSG B on the NRCS WSS and as sandy loam based on soil testing. The most significant differences between the two sites were the vegetation and potential soil compaction. The 17 Mile House site was well-vegetated with tall grasses and showed no obvious indications of compaction. The Parker Town Hall site had short and relatively sparse vegetation and likely has experienced some level of compaction due to the location and nature of the grading.

Results show the non-engineered buffers effectively provided 100% runoff volume reduction with UIA:RPA ratios of 12:1 (17 Mile House) and 4:1 (Parker Town Hall).

## 9.0 RECOMMENDATIONS

The following recommendations should be considered by the project sponsors based on the findings of this Project.

### 9.1 Engineered Grass Swales with Underdrains

#### 9.1.1 *Runoff Reduction “Credits”*

As previously noted, neither MHFD or SEMSWA currently allow for underdrained grass swales to be used to meet the Runoff Reduction Standard. They are primarily used to meet the 20/10 rule and other qualitative runoff reduction requirements. Although results of this study showed measurable runoff volume reduction at two of the monitored swales, the results were too variable among all four swales to recommend any changes to the existing runoff reduction considerations. It would be too optimistic to assume that most existing underdrained swales perform similar to the Central Centennial swale, given some of the issues identified at the other sites. It is possible that swales constructed in the future, according to additional recommendations below, could provide more reliable runoff reduction. Additional monitoring of properly designed, constructed, and maintained swales with underdrains would be needed in order to support a recommendation that underdrained swales could reliably meet a 60% runoff reduction metric.

#### 9.1.2 *Swale Check Dams*

Adding small check dams to swales could increase runoff reduction performance considerably. Currently, design criteria only require check dams where swale slopes are steep, with the check dams intended to limit flow velocities. However, check dams on relatively flat slopes would increase ponded area and infiltration opportunities. The check dams could be limited to just a few inches in height to allow for larger flows to be conveyed relatively unimpeded and could be designed with slopes that still allow for relatively unobstructed maintenance (e.g., mowing).

#### 9.1.3 *Modified Swale Underdrain Designs*

Underdrain designs could also be modified to increase runoff reduction performance. Specifically, underdrains that are constructed only in the lower reach (e.g., 25%) of the swale rather than the entire swale length would provide greater opportunities for infiltration in the upper reaches. The SRTs conducted at the SEMSWA and Central Centennial sites rarely wetted the entire swale using inflow rates and volumes representative of the water quality event. This is because the swale media would become saturated at some “equilibrium wetted length” and the underdrain would become the path of least resistance for swale inflows, rather than infiltrating into underlying soils.

This type of modification would also address the “short-circuiting” issue identified at the RoadSafe site.

Another modification/retrofit that could provide increased runoff reduction is using an orifice plate (or similar flow restriction component) to reduce underdrain discharges and to promote

---

## Runoff Reduction Field Monitoring in Cherry Creek Basin

---

additional infiltration into the subsurface. This modification was not specifically evaluated as part of this study, however, future monitoring efforts could include evaluation of this modification as it is a relatively inexpensive retrofit with great potential for improving RPA performance.

### **9.1.4 Construction and Maintenance**

The project sponsors have various procedures in place intended to ensure RPAs are properly constructed and maintained, however, most of those procedures rely on the engineer of record, contractor and/or property owner to demonstrate compliance. Additional procedures (e.g., increased construction observation) may be warranted since two of the swales appeared to have issues that affected runoff reduction performance.

Proper installation of appropriate growing and/or filter media could be better documented in final construction submittals. Soil sampling and testing and/or field infiltration testing of the media, in addition to photographs showing installation of the various layers could reasonably provide such documentation.

Proper maintenance, particularly related to sediment accumulation, should also be documented in more detail. Photographs of the swale and contributing area may be a reasonable requirement for inspection and maintenance submittals. Digging a few inches into the filter media using a garden shovel and/or collecting soil cores should easily indicate surface clogging and the potential need for media replacement. Future efforts could also include developing standard maintenance protocols for media and vegetation removal as part of restorative maintenance activities.

Lastly, irrigation practices at the swales could be modified to reduce soil saturation and conserve water. Additional information would be needed to evaluate whether over-irrigation was occurring at some of the swales and whether the swale's vegetation could remain healthy at lower infiltration rates or frequencies.

## **9.2 Minimally-engineered and Non-Engineered Infiltration Basins**

Infiltration basins should be included as another RPA option (besides swales and buffers) within Cherry Creek Basin. Under the appropriate site conditions, infiltration basins require relatively little design and construction of engineered infrastructure compared to other SCMs and RPAs. They are particularly well-suited for small projects that only require capture/treatment of the WQCV and where runoff generated from larger events can be safely conveyed through or around the basin. Additionally, these would be suitable in stable watersheds (i.e., low sediment loading) or where pretreatment is provided by another practice.

Where infiltration basins are proposed for future projects, it is recommended that those areas be identified and isolated from construction activities to prevent compaction and sediment loading. Additionally, the existing ("native") soils within the proposed infiltration basin should be analyzed for gradation/texture (at a minimum). The import of filter media may be unnecessary if the native soils show relatively high sand content (e.g., > 60%) and relatively low clay content (e.g., < 15%). Pretreatment may also benefit sites where excess sediment is currently present or may be present to prevent clogged surfaces of RPAs.

## Runoff Reduction Field Monitoring in Cherry Creek Basin

Table 26 summarizes the infiltration basin monitoring results and characteristics that would be relevant to design. Clearly, the relationship between NRCS WSS results and actual infiltration rates are not consistent and supports the MHFD’s recommendations for performing site-specific geotechnical and infiltration tests for full-infiltration designs. Actual infiltration basin designs should be based on measured infiltration rates and runoff volume calculations; however, the field monitoring results suggest UIA:RPA ratios greater than those predicted by modeling (discussed in Section 2.2.1) could be used for initial planning in the Cherry Creek Basin.

**Table 26. Infiltration basin characteristics relevant to potential design criteria**

| RPA                                    | Runoff Volume Reduction <sup>1</sup> | NRCS WSS HSG <sup>2</sup> | Soil Analysis Classification <sup>3</sup> | Infiltration Rates <sup>4</sup> (in/hr) | UIA:RPA    |
|--|--------------------------------------|---------------------------|---|---|------------|
| Lake Loop Infiltration Basin           | 100%                                 | B                         | Sandy loam (HSG B)                        | 5                                       | 9:1        |
| Mountain Loop Infiltration Basin/Swale | 100%                                 | B                         | Sandy loam (HSG B)                        | 0.3-2.4                                 | 3:1<br>5:1 |
| 17 Mile House Infiltration Basin       | 100%                                 | B                         | Sandy clay loam (HSG C)                   | 20-50                                   | <29:1      |

<sup>1</sup> For ambient monitoring events with precipitation depths equal to or less than the water quality event and SRTs with inflows equivalent to the water quality event.

<sup>2</sup> NRCS Web Soil Survey (see Appendix 2).

<sup>3</sup> Based on actual soil samples (see Appendix 2).

<sup>4</sup> Calculated as (peak depth)/(time to full infiltration from time of peak).

### 9.3 Non-engineered Grass/Vegetated Buffers

Grass/vegetated buffers should continue to be used as RPAs as they provide great opportunities for runoff reduction. Where relatively small, “retrofit” projects or Tier 2 development projects are proposed, opportunities for using adjacent, “undisturbed” pervious areas should strongly be considered. Future monitoring and/or analysis should be considered to evaluate the potential use of nonengineered swales/buffers for 20/10 applications.

Table 27 summarizes the buffer monitoring results and characteristics that would be relevant to design. Infiltration rate testing and an assessment of existing vegetation should be required where “undisturbed” areas are proposed for buffers as those factors could influence the buffer size (area). The 2012 Regulation 72 criteria of a minimum 50-foot buffer length is reasonable based on the results of this Project and should remain for initial planning. The field monitoring results suggest UIA:RPA ratios greater than those predicted by modeling could be used for initial planning.

## Runoff Reduction Field Monitoring in Cherry Creek Basin

---

**Table 27. Grass/Vegetated Buffer characteristics relevant to potential design criteria**

| RPA                     | Runoff Volume Reduction <sup>1</sup> | NRCS WSS HSG <sup>2</sup> | Soil Analysis Classification <sup>3</sup> | Infiltration Rates <sup>4</sup> (in/hr) | UIA:RPA |
|-------------------------|--------------------------------------|---------------------------|---|---|---------|
| 17 Mile House Buffer    | 100%                                 | B                         | Sandy loam (HSG B)                        | 15-32                                   | <24:1   |
| Parker Town Hall Buffer | 100%                                 | B                         | Sandy loam (HSG B)                        | 5-6                                     | 4:1     |

<sup>1</sup> For SRTs with inflow volumes equivalent to the water quality event.

<sup>2</sup> NRCS Web Soil Survey (see Appendix 2).

<sup>3</sup> Based on actual soil samples (see Appendix 2).

<sup>4</sup> Infiltration rates calculated as (inflow volume/wetted area)/(duration of SRT)



# Runoff Reduction Field Monitoring in Cherry Creek Basin

---

## 10.0 REFERENCES

- Civil Resources, LLC. 2017. Phase III Drainage Report for Smith & Smith Industrial Park. SEMSWA Case No. DPR18-00001. SEMSWA, Centennial, CO, Revised April 2018.
- CKE Engineering, Inc. 2017. Phase III Drainage Report for RoadSafe Traffic Systems. Arapahoe County Case No. A17-007. Arapahoe County, CO, Revised November 2017.
- Colorado Water Quality Control Commission (WQCC). 2022. *Regulation No. 72 – Cherry Creek Reservoir Control Regulation*.
- Colorado Water Quality Control Division (WQCD). 2018. MS4 General Permit. Permit No. COR-080000. CDPS General Permit, Stormwater Discharges Associated with Municipal Separate Storm Sewer Systems (MS4s) that Discharge to the Cherry Creek Reservoir Drainage System.
- Colorado Water Quality Control Division (WQCD). 2020. MS4 General Permit. Permit No. COR-090000. CDPS General Permit, Stormwater Discharges Associated with Municipal Separate Storm Sewer Systems (MS4s), Authorization to Discharge under the Colorado Discharge Permit System.
- Muller Engineering Company, Inc. 2013. Contract Drawings for Construction of Mountain & Lake Loop Shoreline Stabilization. Cherry Creek Basin Water Quality Authority.
- Muller Engineering Company, Inc. 2014. Contract Drawings for Construction of Water Quality Demonstration Campus, SEMSWA, Centennial, CO.
- Soil Survey Staff, Natural Resources Conservation Service (NRCS), United States Department of Agriculture. Web Soil Survey. Available online. Accessed December 8, 2023.
- WBC Engineering & CM, LLC. 2019. Phase 3 Drainage Report for Elevate at Central Centennial. SEMSWA Case No. DPR19-00063. SEMSWA, Centennial, CO, Revised February 2020.

## Appendix 1: Weir Box Design and Rating Curves

## Weir Box Design

The following design was used at the SEMSWA, Central Centennial, and Smith & Smith sites:

### SEMSWA Site Weir Box Design

Drawing not to scale

Actual weir box dimensions may vary slightly

Most important V-notch weir dimensions

- MUST be 90-degree angle
- MUST have vertical length of 7 inches

Approximate Rating Curve for 90 degree V-notch weir

| h (in) | Q (gpm) |
|--------|---------|
| 1      | 2.4     |
| 2      | 13.1    |
| 3      | 35.7    |
| 4      | 72.8    |
| 5      | 126.6   |
| 6      | 199.1   |
| 7      | 292.1   |

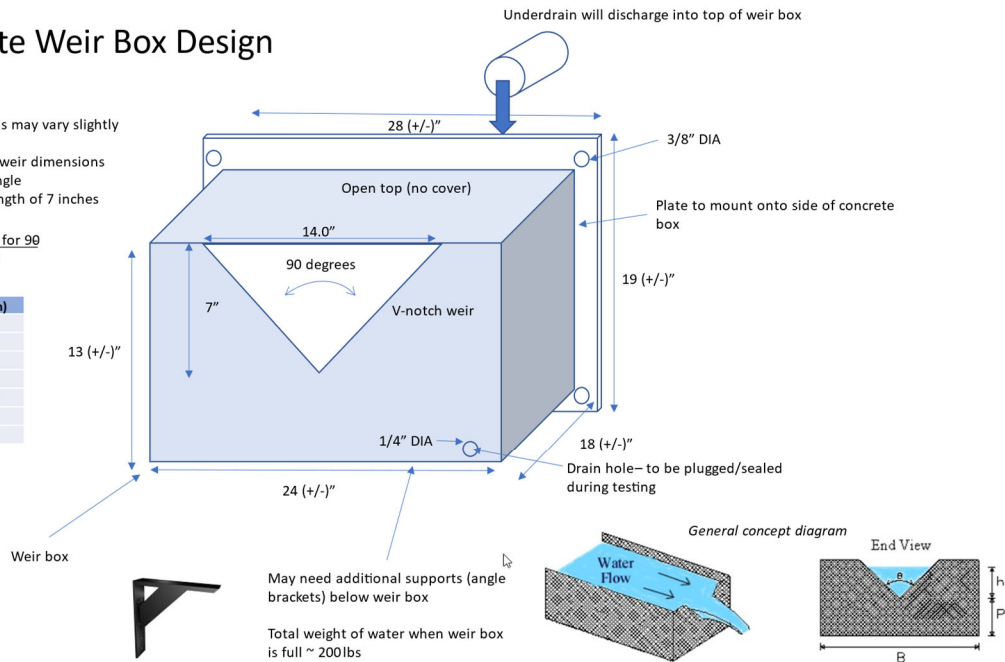

The following design was used at the RoadSafe site:

### Road Safe Site Weir Box Design

Drawing not to scale

Actual weir box dimensions may vary slightly

Most important rectangular weir dimensions

- MUST be 12 inches long
- MUST have vertical length of 5 inches

Approximate Rating Curve for 12" rectangular weir

| h <sub>1</sub> (in) | Q (gpm) |
|---------------------|---------|
| 1                   | 36      |
| 2                   | 100     |
| 3                   | 181     |
| 4                   | 278     |
| 5                   | 388     |

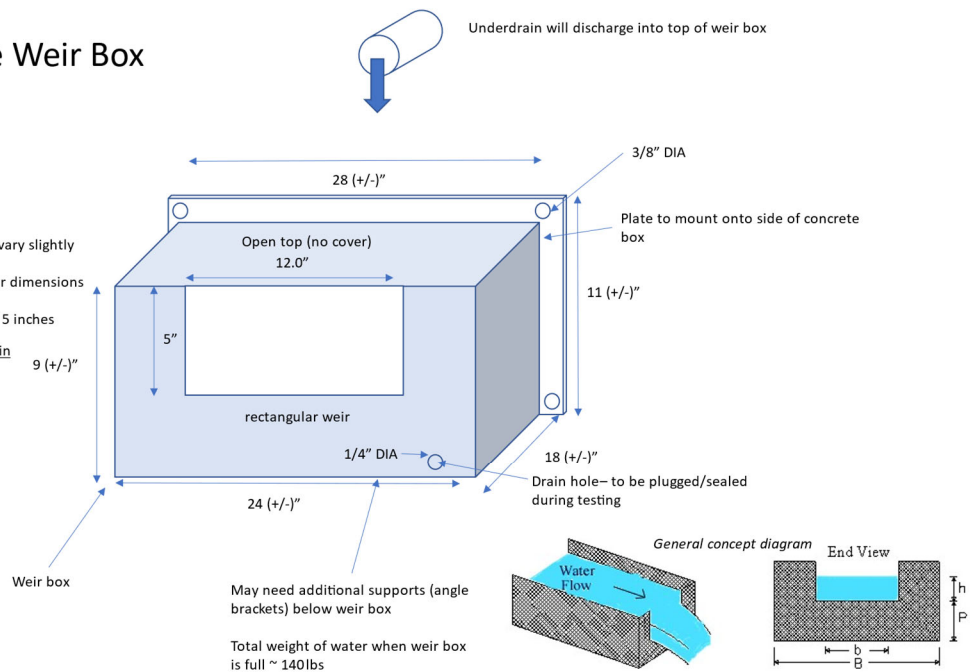

## Appendix 2: Soil Sampling Results



Colorado State University

CSU SPUR

Department of Soil and Crop Sciences

Soil, Water and Plant Testing Laboratory

1120 Campus Delivery

Fort Collins, CO 80523-1120

Tel: (970) 491-5061

Email: soiltesting@colostate.edu

LRE Water

c/o Erin Stewart

1221 Auraria Parkway

Denver, CO 80204

Date Received: 6/23/2023

Date Reported: 7/28/2023

Date Revised: 8/3/2023

| Lab ID    | Sample ID             | Depth | Sample Weight (g) | >4.75mm       | 4.75-2 mm | 2-0.425 mm | 0.425-0.212 mm | 0.212-0.075 mm | <0.075 mm |
|-----------|-----------------------|-------|-------------------|---------------|-----------|------------|----------------|----------------|-----------|
|           |                       |       |                   | ----- g ----- |           |            |                |                |           |
| 2023S1851 | ESS Test Location #1  |       | 500.0             | 50.1          | 70.4      | 236.3      | 81.7           | 44.5           | 16.6      |
| 2023S1852 | ESS Test Location #2  |       | 500.0             | 34.0          | 51.3      | 214.7      | 120.9          | 60.7           | 18.1      |
| 2023S1853 | ESS Test Location #3  |       | 500.0             | 9.5           | 12.8      | 240.6      | 177.4          | 45.8           | 13.0      |
| 2023S1854 | TL Test Location #1   |       | 500.0             | 1.4           | 5.0       | 272.6      | 162.7          | 47.6           | 8.1       |
| 2023S1855 | TL Test Location #2   |       | 500.0             | 1.5           | 1.3       | 252.5      | 180.4          | 55.7           | 7.8       |
| 2023S1856 | TL Test Location #3   |       | 500.0             | 0.0           | 0.5       | 256.3      | 170.9          | 62.6           | 9.3       |
| 2023S1857 | ML Sample #1 Basin    |       | 500.0             | 8.9           | 35.5      | 319.3      | 80.6           | 38.9           | 16.2      |
| 2023S1858 | ML Sample #1 Basin 6" |       | 500.0             | 11.2          | 58.0      | 299.5      | 75.9           | 33.2           | 20.9      |
| 2023S1859 | ML Sample #2 Swale    |       | 500.0             | 32.4          | 66.2      | 283.7      | 66.3           | 34.1           | 16.5      |
| 2023S1860 | ML Sample #3 Native   |       | 500.0             | 17.2          | 78.5      | 224.6      | 61.0           | 64.2           | 54.1      |
| 2023S1861 | LL Sample #4 Basin    |       | 500.0             | 5.0           | 18.3      | 192.8      | 227.4          | 47.3           | 9.4       |
| 2023S1862 | LL Sample #5 Basin    |       | 500.0             | 34.3          | 73.6      | 275.9      | 68.8           | 34.5           | 11.3      |
| 2023S1863 | LL Sample #5 Basin 6" |       | 500.0             | 6.7           | 24.6      | 374.8      | 72.2           | 19.4           | 2.0       |
| 2023S1864 | LL Sample #6 Native   |       | 500.0             | 7.5           | 70.2      | 262.5      | 63.6           | 58.4           | 38.1      |
| 2023S1865 | ML Swale #2 6"        |       | 500.0             | 13.1          | 64.7      | 313.7      | 64.5           | 28.8           | 14.5      |



| Lab ID    | Sample ID             | Depth | Sample Weight (g) | >4.75mm       | 4.75-2 mm | 2-0.425 mm | 0.425-0.212 mm | 0.212-0.075 mm | <0.075 mm |
|-----------|-----------------------|-------|-------------------|---------------|-----------|------------|----------------|----------------|-----------|
|           |                       |       |                   | ----- % ----- |           |            |                |                |           |
| 2023S1851 | ESS Test Location #1  |       | 500.0             | 10.0          | 14.1      | 47.3       | 16.4           | 8.9            | 3.3       |
| 2023S1852 | ESS Test Location #2  |       | 500.0             | 6.8           | 10.3      | 43.0       | 24.2           | 12.1           | 3.6       |
| 2023S1853 | ESS Test Location #3  |       | 500.0             | 1.9           | 2.6       | 48.2       | 35.5           | 9.2            | 2.6       |
| 2023S1854 | TL Test Location #1   |       | 500.0             | 0.3           | 1.0       | 54.8       | 32.7           | 9.6            | 1.6       |
| 2023S1855 | TL Test Location #2   |       | 500.0             | 0.3           | 0.3       | 50.6       | 36.1           | 11.2           | 1.6       |
| 2023S1856 | TL Test Location #3   |       | 500.0             | 0.0           | 0.1       | 51.3       | 34.2           | 12.5           | 1.9       |
| 2023S1857 | ML Sample #1 Basin    |       | 500.0             | 1.8           | 7.1       | 64.0       | 16.1           | 7.8            | 3.2       |
| 2023S1858 | ML Sample #1 Basin 6" |       | 500.0             | 2.2           | 11.6      | 60.1       | 15.2           | 6.7            | 4.2       |
| 2023S1859 | ML Sample #2 Swale    |       | 500.0             | 6.5           | 13.3      | 56.8       | 13.3           | 6.8            | 3.3       |
| 2023S1860 | ML Sample #3 Native   |       | 500.0             | 3.5           | 15.7      | 45.0       | 12.2           | 12.9           | 10.8      |
| 2023S1861 | LL Sample #4 Basin    |       | 500.0             | 1.0           | 3.7       | 38.6       | 45.5           | 9.5            | 1.9       |
| 2023S1862 | LL Sample #5 Basin    |       | 500.0             | 6.9           | 14.8      | 55.4       | 13.8           | 6.9            | 2.3       |
| 2023S1863 | LL Sample #5 Basin 6" |       | 500.0             | 1.3           | 4.9       | 75.0       | 14.5           | 3.9            | 0.4       |
| 2023S1864 | LL Sample #6 Native   |       | 500.0             | 1.5           | 14.0      | 52.5       | 12.7           | 11.7           | 7.6       |
| 2023S1865 | ML Swale #2 6"        |       | 500.0             | 2.6           | 13.0      | 62.8       | 12.9           | 5.8            | 2.9       |

| Lab ID    | Sample ID             | Depth | Composite | >4.75mm                                  | 4.75-2 mm | 2-0.425 mm | 0.425-0.212 mm | 0.212-0.075 mm | <0.075 mm |
|-----------|-----------------------|-------|-----------|--|-----------|------------|----------------|----------------|-----------|
|           |                       |       |           | ----- Total P -----<br>----- mg/Kg ----- |           |            |                |                |           |
| 2023S1851 | ESS Test Location #1  |       | 917.7     | 159.6                                    | 631.1     | 655.8      | 419.8          | 632.3          | 700.8     |
| 2023S1852 | ESS Test Location #2  |       | 439.2     | 220.7                                    | 327.5     | 445.5      | 232.8          | 378.1          | 496.3     |
| 2023S1853 | ESS Test Location #3  |       | 258.3     | 45.2                                     | 397.2     | 378.6      | 213.1          | 414.6          | 550.4     |
| 2023S1854 | TL Test Location #1   |       | 122.2     | 425.3                                    | 921.5     | 79.9       | 84.8           | 171.7          | 508.7     |
| 2023S1855 | TL Test Location #2   |       | 218.8     | 272.9                                    | 228.0     | 160.4      | 135.7          | 215.4          | 460.4     |
| 2023S1856 | TL Test Location #3   |       | 115.8     | **                                       | 295.0     | 131.3      | 103.3          | 229.0          | 480.3     |
| 2023S1857 | ML Sample #1 Basin    |       | 349.3     |  |           |            |                |                |           |
| 2023S1858 | ML Sample #1 Basin 6" |       | 426.9     |  |           |            |                |                |           |
| 2023S1859 | ML Sample #2 Swale    |       | 371.9     |  |           |            |                |                |           |
| 2023S1860 | ML Sample #3 Native   |       | 193.7     |  |           |            |                |                |           |
| 2023S1861 | LL Sample #4 Basin    |       | 533.5     |  |           |            |                |                |           |
| 2023S1862 | LL Sample #5 Basin    |       | 325.3     |  |           |            |                |                |           |
| 2023S1863 | LL Sample #5 Basin 6" |       | 226.0     |  |           |            |                |                |           |
| 2023S1864 | LL Sample #6 Native   |       | 548.8     |  |           |            |                |                |           |
| 2023S1865 | ML Swale #2 6"        |       | 370.9     |  |           |            |                |                |           |

\*\* No Fraction



**Soil, Water and Plant Testing Laboratory**  
 4780 National Western Drive  
 Denver, CO 80216  
 Tel: (970) 491-5061  
 Email: soiltestinglab@colostate.edu

Wright Water Engineers  
 c/o Chris Olson

Lab ID: 2023S3381 to 2023S3394

Date Received: 11/10/2023  
 Date Reported: 11/27/2023

| Lab ID    | Sample ID        | Depth<br>in | pH 1:1 | EC 1:1 | Lime<br>Estimate | OM (%) | KCl<br>NO <sub>3</sub> <sup>-</sup> | Clsen<br>Bicarbona<br>P | M-3<br>S | K   | Ammonium Acetate |     |     |
|-----------|------------------|-------------|--------|--------|------------------|--------|-------------------------------------|-------------------------|----------|-----|------------------|-----|-----|
|           |                  |             |        |        |                  |        |                                     |                         |          |     | Ca               | Mg  | Na  |
|           |                  |             |        |        |                  |        |                                     |                         |          |     | ppm              |     |     |
| 2023S3381 | Smith/Smith 0-6  | 0-6         | 8.6    | 0.3    | LOW              | 4.5    | 1.6                                 | 15.7                    | 18.3     | 157 | 2354             | 209 | 478 |
| 2023S3382 | Smith/Smith 6-12 | 6-12        | 8.6    | 0.54   | HIGH             | 2.2    | 1.7                                 | 11.2                    | 21       | 211 | 4396             | 480 | 977 |
| 2023S3383 | Central 0-6      | 0-6         | 8.3    | 0.06   | NONE             | 0.6    | 0.7                                 | 44.3                    | 5.2      | 49  | 949              | 83  | 33  |
| 2023S3384 | Central 6-12     | 6-12        | 8.6    | 0.09   | LOW              | 0.6    | 1.1                                 | 16.6                    | 5.9      | 59  | 1837             | 105 | 38  |
| 2023S3385 | Roadsafe 0-6     | 0-6         | 8.3    | 0.11   | LOW              | 0.6    | < 0.1                               | 11.9                    | 5.3      | 37  | 1407             | 71  | 43  |
| 2023S3386 | Roadsafe 6-12    | 6-12        | 8.5    | 0.11   | LOW              | 0.4    | < 0.1                               | 10                      | 7.4      | 35  | 1192             | 69  | 42  |
| 2023S3387 | SEMSWA 0-6       | 0-6         | 8      | 0.1    | LOW              | 2.1    | < 0.1                               | 73.2                    | 19.9     | 69  | 1459             | 110 | 45  |
| 2023S3388 | SEMSWA 6-12      | 6-12        | 8.3    | 0.06   | NONE             | 0.6    | < 0.1                               | 39.4                    | 8.7      | 39  | 937              | 73  | 34  |
| 2023S3389 | 17-Buf 0-6       | 0-6         | 7.6    | 0.09   | NONE             | 2.1    | < 0.1                               | 27.1                    | 9.4      | 297 | 1266             | 193 | 41  |
| 2023S3390 | 17- Buf 6-12     | 6-12        | 7.8    | 0.09   | NONE             | 1.5    | < 0.1                               | 29.5                    | 6.6      | 322 | 1119             | 197 | 41  |
| 2023S3391 | 17-Inf 0-6       | 0-6         | 6.9    | 0.13   | NONE             | 5.4    | 6.8                                 | 44.3                    | 11       | 320 | 1647             | 237 | 67  |
| 2023S3392 | 17 Inf 6-12      | 6-12        | 6.7    | 0.11   | NONE             | 2.6    | 3.6                                 | 61                      | 9.4      | 415 | 1243             | 183 | 66  |
| 2023S3393 | Parker TH 0-6    | 0-6         | 8.3    | 0.09   | HIGH             | 1.2    | 0.1                                 | 14.5                    | 35.4     | 204 | 3470             | 202 | 14  |
| 2023S3394 | PTH 6-12         | 6-12        | 8.4    | 0.08   | LOW              | 0.8    | 0.2                                 | 9.3                     | 9.9      | 117 | 1507             | 116 | 13  |

Lab ID: 2023S3381 to 2023S3394

Date Received: 11/10/2023

Date Reported: 11/27/2023

| Lab ID    | Sample ID        | Depth<br>in | CEC<br>mmho/cm | Base Saturation<br>% |    |    |    |    | Hot Water |      | DTPA<br>ppm |     |      |
|-----------|------------------|-------------|----------------|----------------------|----|----|----|----|-----------|------|-------------|-----|------|
|           |                  |             |                | H                    | K  | Ca | Mg | Na | B         | Zn   | Fe          | Mn  | Cu   |
| 2023S3381 | Smith/Smith 0-6  | 0-6         | 16             | 0                    | 3  | 73 | 11 | 13 | 0.46      | 5.59 | 30.9        | 6.2 | 1.04 |
| 2023S3382 | Smith/Smith 6-12 | 6-12        | 30.8           | 0                    | 2  | 71 | 13 | 14 | 0.45      | 0.66 | 20.3        | 5.8 | 1.13 |
| 2023S3383 | Central 0-6      | 0-6         | 5.7            | 0                    | 2  | 83 | 12 | 3  | 0.26      | 1.37 | 9.4         | 1   | 0.38 |
| 2023S3384 | Central 6-12     | 6-12        | 10.4           | 0                    | 1  | 89 | 8  | 2  | 0.18      | 0.58 | 6.8         | 1.2 | 0.23 |
| 2023S3385 | Roadsafe 0-6     | 0-6         | 7.9            | 0                    | 1  | 89 | 8  | 2  | 0.14      | 0.83 | 5.8         | 1   | 0.17 |
| 2023S3386 | Roadsafe 6-12    | 6-12        | 6.8            | 0                    | 1  | 88 | 8  | 3  | 0.17      | 0.63 | 5.6         | 1.4 | 0.18 |
| 2023S3387 | SEMSWA 0-6       | 0-6         | 8.6            | 0                    | 2  | 85 | 11 | 2  | 0.42      | 9.82 | 10.9        | 2   | 0.64 |
| 2023S3388 | SEMSWA 6-12      | 6-12        | 5.5            | 0                    | 2  | 84 | 11 | 3  | 0.13      | 3.17 | 8.7         | 1.4 | 0.44 |
| 2023S3389 | 17-Buf 0-6       | 0-6         | 8.9            | 0                    | 9  | 71 | 18 | 2  | 0.49      | 1.69 | 12.5        | 3.7 | 0.49 |
| 2023S3390 | 17- Buf 6-12     | 6-12        | 8.2            | 0                    | 10 | 68 | 20 | 2  | 0.38      | 0.69 | 13          | 3.2 | 0.4  |
| 2023S3391 | 17-Inf 0-6       | 0-6         | 11.3           | 0                    | 7  | 73 | 17 | 3  | 0.95      | 5.72 | 18          | 3.7 | 0.47 |
| 2023S3392 | 17 Inf 6-12      | 6-12        | 9.1            | 0                    | 12 | 68 | 17 | 3  | 0.62      | 2.44 | 24.7        | 4.5 | 0.54 |
| 2023S3393 | Parker TH 0-6    | 0-6         | 19.6           | 0                    | 3  | 88 | 9  | 0  | 0.27      | 0.27 | 4.2         | 0.8 | 0.58 |
| 2023S3394 | PTH 6-12         | 6-12        | 8.9            | 0                    | 3  | 85 | 11 | 1  | 0.21      | 0.22 | 3.3         | 0.6 | 0.32 |

Lab ID: 2023S3381 to 2023S3394

Date Received: 11/10/2023

Date Reported: 11/27/2023

| Lab ID    | Sample ID        | Depth<br>in | Soil Texture<br>% |      |      | Texture Class   |
|-----------|------------------|-------------|-------------------|------|------|-----------------|
|           |                  |             | Sand              | Silt | Clay |                 |
| 2023S3381 | Smith/Smith 0-6  | 0-6         | 50                | 20   | 30   | Sandy Clay Loam |
| 2023S3382 | Smith/Smith 6-12 | 6-12        | 34                | 26   | 40   | Clay Loam       |
| 2023S3383 | Central 0-6      | 0-6         | 65                | 12   | 23   | Sandy Clay Loam |
| 2023S3384 | Central 6-12     | 6-12        | 78                | 10   | 12   | Sandy Loam      |
| 2023S3385 | Roadsafe 0-6     | 0-6         | 78                | 10   | 12   | Sandy Loam      |
| 2023S3386 | Roadsafe 6-12    | 6-12        | 80                | 8    | 12   | Sandy Loam      |
| 2023S3387 | SEMSWA 0-6       | 0-6         | 80                | 8    | 12   | Sandy Loam      |
| 2023S3388 | SEMSWA 6-12      | 6-12        | 80                | 8    | 12   | Sandy Loam      |
| 2023S3389 | 17-Buf 0-6       | 0-6         | 64                | 16   | 20   | Sandy Loam      |
| 2023S3390 | 17- Buf 6-12     | 6-12        | 62                | 18   | 20   | Sandy Loam      |
| 2023S3391 | 17-Inf 0-6       | 0-6         | 56                | 20   | 24   | Sandy Clay Loam |
| 2023S3392 | 17 Inf 6-12      | 6-12        | 60                | 18   | 22   | Sandy Clay Loam |
| 2023S3393 | Parker TH 0-6    | 0-6         | 64                | 16   | 20   | Sandy Loam      |
| 2023S3394 | PTH 6-12         | 6-12        | 76                | 8    | 16   | Sandy Loam      |

**DENVER**

2490 W. 26<sup>th</sup> Avenue Suite 100A  
Denver, Colorado 80211  
Phone: 303.480.1700  
Fax: 303.480.1020

**GLENWOOD SPRINGS**

818 Colorado Avenue  
P.O.Box 219  
Glenwood Springs, Colorado 81602  
Phone: 970.945.7755  
Fax: 970.945.9210

**DURANGO**

1666 N. Main Avenue Suite C  
Durango, Colorado 81301  
Phone: 970.259.7411  
Fax: 970.259.8758

[www.wrightwater.com](http://www.wrightwater.com)



**Wright Water Engineers, Inc.**